

# Empirical Whole Model Validation

## Modelling Specification

**Twin House Experiment**

**IEA EBC Annex 71**

**Validation of Building Energy Simulation Tools**

**Version 1.0**

**Matthias Kersken<sup>1</sup> and Paul Strachan<sup>2</sup>**

**27.04.2020**

1. Fraunhofer-Institut für Bauphysik IBP, Holzkirchen, 83626 Valley, Germany  
[matthias.kersken@ibp.fraunhofer.de](mailto:matthias.kersken@ibp.fraunhofer.de)

*The contributions of the Fraunhofer Institute for Building Physics IBP were funded by the German Federal Ministry of Energy and Economic Affairs BMWi under the registration number 03ET1509A.*

2. Energy Systems Research Unit, University of Strathclyde, Glasgow, G1 1XJ, UK  
[paul@esru.strath.ac.uk](mailto:paul@esru.strath.ac.uk)

### Versions

version	changes	date
1.0	-	27.04.2020

## **TABLE OF CONTENTS**

<b>1. INTRODUCTION</b>	<b>6</b>
1.1. OVERVIEW	6
1.2. IEA EBC ANNEX 58	7
1.3. CHANGES TO EXPERIMENTAL CONFIGURATION FOR ANNEX 71 EXPERIMENT	8
1.4. VALIDATION PROCEDURE	9
<b>2. EXPERIMENTAL DESIGN</b>	<b>10</b>
<b>3. EXPERIMENT</b>	<b>11</b>
3.1. CLIMATE AND LOCATION	11
3.2. BASELINE MEASUREMENT	11
3.2.1 <i>Air tightness</i>	11
3.2.2 <i>Tracer Gas</i>	13
3.2.3 <i>Analysis of the coheating data</i>	14
3.3. GEOMETRY	16
3.4. CONSTRUCTIONS	19
3.4.1 <i>Internal doors</i>	20
3.4.2 <i>Trap door</i>	20
3.5. GLAZING OPTICAL AND THERMAL PROPERTIES	21
3.6. ROLLER BLINDS	23
3.7. THERMAL BRIDGES	25
3.8. VENTILATION	29
3.9. HEATING / COOLING	31
3.10. ELECTRICAL HEATING (N2 HOUSE)	31
3.11. HEAT PUMP (O5 HOUSE)	33
3.12. DOMESTIC HOT WATER (O5 HOUSE)	34
3.13. UNDERFLOOR HEATING (O5)	34
3.14. HYDRONIC SCHEME	36
3.15. SYNTHETIC USER	36
3.15.1 <i>Occupancy</i>	37
3.15.2 <i>Internal heat sources</i>	37
3.15.3 <i>Internal humidity sources</i>	39
3.15.4 <i>Internal CO<sub>2</sub> sources</i>	41
3.15.5 <i>Set temperatures</i>	41
3.15.6 <i>External window and internal doors</i>	42
3.15.7 <i>Roller blinds</i>	43
3.15.8 <i>Domestic Hot Water</i>	44
3.16. WEATHER	44
3.17. GROUND PROPERTIES	44
<b>4. EXPERIMENTAL SCHEDULE</b>	<b>45</b>
4.1. INITIALISATION PHASE(S)	48
4.2. COHEATING PHASE	48
4.3. USER-1 PHASE	48
4.4. USER-2 PHASE	48
4.5. FDD PHASE	49
4.6. USER-3 PHASE: INCLUDING MOISTURE RELEASE	49
4.7. FREE PRBS-PHASE	49
4.8. FREE-FLOAT PHASE	49
4.9. TRACER GAS AIR CHANGE RATE MEASUREMENT (O5 HOUSE ONLY)	50
<b>5. INSTRUMENTATION</b>	<b>50</b>
5.1. OVERVIEW	50
5.2. COHEATING CONCEPT	51
5.3. TRACER GAS CONCEPT	52

<b>6.</b>	<b>PRACTICAL ASPECTS OF MODELLING THE MEASURED DATA</b>	<b>53</b>
6.1.	OVERVIEW	53
6.2.	MAIN EXPERIMENT: OPERATIONAL DETAILS	55
6.3.	EXTENDED EXPERIMENT: OPERATIONAL DETAILS	57
<b>7.</b>	<b>ACKNOWLEDGEMENTS</b>	<b>59</b>
<b>8.</b>	<b>REFERENCES</b>	<b>60</b>

## List of Figures

FIGURE 1:	VIEWS OF TWIN HOUSES IN HOLZKIRCHEN, GERMANY. ....	6
FIGURE 2:	LOCATION OF TWIN HOUSES IN HOLZKIRCHEN, GERMANY. ....	7
FIGURE 3:	MEASURED SF <sub>6</sub> CONCENTRATION (LEFT) AND RESULTING AIR CHANGE RATE (RIGHT) DURING THE INFILTRATION TRACER GAS EXPERIMENT AFTER THE END OF THE EXTENDED EXPERIMENT WITHOUT MECHANICAL VENTILATION. ....	14
FIGURE 4:	REGRESSION ANALYSIS OF THE COHEATING DATA. LEFT FOR O5, RIGHT FOR N2. ....	14
FIGURE 5:	BASELINE MEASUREMENT CONDUCTED DURING THE COHEATING TEST, CONDUCTED BETWEEN 7 <sup>TH</sup> DECEMBER 2018 18:00 AND 19 <sup>TH</sup> DECEMBER 2018 09:00. ....	15
FIGURE 6:	FLOOR PLAN GROUND FLOOR. ....	16
FIGURE 7:	FLOOR PLAN ATTIC. ....	16
FIGURE 8:	TWIN HOUSE VIEWS: CLOCKWISE FROM TOP LEFT: SOUTH, NORTH, WEST, AND EAST. ....	17
FIGURE 9:	OVERVIEW OF THE WINDOW TYPES. THE WINDOW TYPES ARE SHOWN AS RED NUMBERS. ....	17
FIGURE 10:	GEOMETRY OF THE GROUND FLOORS' FOUR COLUMNS. ....	18
FIGURE 11:	INTERNAL DOOR. ....	20
FIGURE 12:	OPERATED EXTERNAL WINDOW IN TILTED POSITION. ....	22
FIGURE 13:	DETAILS OF ROLLER BLINDS. ....	24
FIGURE 14:	WALL – CEILING JOINT WITH 80 MM INSULATION. MODEL AND TEMPERATURES. ....	25
FIGURE 15:	WALL – WALL JOINT WITH 70 MM INSULATION. MODEL AND TEMPERATURES. ....	26
FIGURE 16:	WALL – FLOOR JOINT WITH 70 MM INSULATION. MODEL AND TEMPERATURES. ....	27
FIGURE 17 :	NAMING OF A ROOF'S COMPONENTS [13]. ....	29
FIGURE 18:	FLOOR PLAN GROUND FLOOR. ....	30
FIGURE 19:	FLOOR PLAN ATTIC. ....	31
FIGURE 20:	ELECTRIC HEATER. ....	32
FIGURE 21:	HEATER SPECIFICATIONS. ....	32
FIGURE 22:	HEATER LAYOUT. ....	33
FIGURE 23:	EXTERNAL INSTALLATION OF THE TWIN HOUSES VAILLANT "AROTHERM VWL 55/2 A" AIR SOURCE HEAT PUMP, LEFT IN SUMMER, RIGHT IN WINTER. ....	33
FIGURE 24:	SPIRAL PIPES OF THE DINING ROOM IN THE GROUND FLOORS (LEFT) AND THE CHILD 2 ROOMS' SERPENTINE PIPES IN THE ATTICS' (RIGHT) UNDERFLOOR HEATING DURING INSTALLATION. ....	35
FIGURE 25:	HYDRONIC SCHEME OF THE TEST HOUSE O5'S HEAT AND DHW INSTALLATION INCLUDING THE INSTRUMENTATION. ....	36
FIGURE 26:	TYPICAL OCCUPANCY PROFILES FOR TWO DAYS. ....	37
FIGURE 27:	RESULTING INTERNAL HEAT GAINS FOR TWO EXAMPLE DAYS. ....	38
FIGURE 28:	OVERVIEW OF THE INTERNAL HEAT GAINS FOR THE ENTIRE BUILDING FOR THE COMPLETE TEST PERIOD. THE BRIGHT, YELLOW SECTION IN APRIL/MAY IS THE PRBS. ....	38
FIGURE 29:	REALISATION OF THE INTERNAL MOISTURE SOURCE THROUGH THE LIVING ROOM'S SUPPLY AIR SYSTEM. ....	39
FIGURE 30:	INTERNAL MOISTURE GAINS FOR THE ENTIRE BUILDING FOR THE COMPLETE PERIOD. ....	40
FIGURE 31:	COMPARISON BETWEEN THE INTERNAL HEAT AND MOISTURE LOAD PROFILES OVER A PERIOD OF EIGHT DAYS. ....	41
FIGURE 32:	RESULTING OCCUPANCY AND SET TEMPERATURES FOR TWO EXAMPLE DAYS. ....	42
FIGURE 33:	CO <sub>2</sub> CYCLE OVER THE YEARS 2014 – 2019 IN HOLZKIRCHEN; 1 HOUR SAMPLING. ....	43
FIGURE 34:	DOMESTIC HOT WATER TAPPINGS DURING THE USER-1 PHASE. ....	44
FIGURE 35:	EXPERIMENTAL SCHEDULE. ....	45

FIGURE 36: SETUP OF ELECTRICAL HEATERS AND FANS DURING THE COHEATING TEST IN THE GROUND FLOOR AND THE ATTIC.....	51
FIGURE 37: ILLUSTRATION OF THE TRACER GAS CONCEPT ON THE GROUND FLOOR (LEFT) AND THE ATTIC SPACE (RIGHT).....	52
FIGURE 38: SELECTION OF THE MAIN EXPERIMENT'S MEASUREMENT DATA OF THE O5 HOUSE (RED) AND THE N2 HOUSE (BLACK). ....	57
FIGURE 39: SELECTION OF THE EXTENDED EXPERIMENT'S MEASUREMENT DATA OF THE O5 HOUSE (RED) AND THE N2 HOUSE (BLACK).....	59

## List of Tables

TABLE 1: RESULTS OF THE BLOWER DOOR TEST CARRIED OUT ON NOVEMBER 29, 2018. ....	13
TABLE 2: SPECIFICATION OF THE WINDOW TYPES' PROPERTIES .....	18
TABLE 3: U-VALUES OF THE TWIN HOUSES CONSTRUCTIONS. ....	19
TABLE 4: GLAZING OPTICAL PROPERTIES: NFRC.....	21
TABLE 5: GLAZING OPTICAL PROPERTIES: EN410 .....	21
TABLE 6: LINEAR THERMAL TRANSMITTANCE FOR WALL – CEILING JOINT IN W/MK. ....	25
TABLE 7: LINEAR THERMAL TRANSMITTANCES FOR WALL – CEILING JOINT IN W/MK.....	26
TABLE 8: LINEAR THERMAL TRANSMITTANCE FOR WALL – WALL JOINT IN W/MK. ....	26
TABLE 9: LINEAR THERMAL TRANSMITTANCE FOR WALL – FLOOR JOINT IN W/MK. ....	27
TABLE 10: LINEAR THERMAL TRANSMITTANCES FOR WALL – FLOOR JOINT IN W/MK.....	27
TABLE 11: THERMAL BRIDGES OF THE TWIN HOUSES.....	28
TABLE 12: AIR BODIES OF THE EXPERIMENT (NOT CONSIDERING THE AIR SPACE IN THE DOOR FRAMES). .....	30
TABLE 13: RESULTING AIR FLOWS. ....	30
TABLE 14: TECHNICAL SPECIFICATIONS (COP) OF THE HEAT PUMP VAILLANT AROTHERM VWL 55/2 A .....	34
TABLE 15: OVERVIEW OF THE GROUND FLOOR UNDERFLOOR HEATING. ....	35
TABLE 16: OPERATION CYCLE OF THE OPERABLE EXTERNAL WINDOW AND INTERNAL DOOR. ....	42
TABLE 17: EXPERIMENTAL CONFIGURATION OF ALL PHASES. ....	46

# 1. Introduction

## 1.1. Overview

This document sets out the specification for the empirical validation experiment conducted on the Twin Houses at the Fraunhofer IBP test site in Holzkirchen, Germany in the winter of 2018/19, as part of IEA EBC Annex 71. The details are also relevant for the common exercises of Subtasks 2 and 3 in the Annex 71, where the focus is on using the measured data to identify model parameters and for automatic fault detection research.

This document, together with the additional information provided (images, thermal bridge calculations, layout drawings, experimental details and experimental data) constitutes a full specification of the experiment.

The focus of the experiments is the Twin Houses. Figure 1 and Figure 2 show the twin houses. House O5 is on the right, in the top left photograph and on the left, in the top right photograph of Figure 1.



Figure 1: Views of Twin Houses in Holzkirchen, Germany.

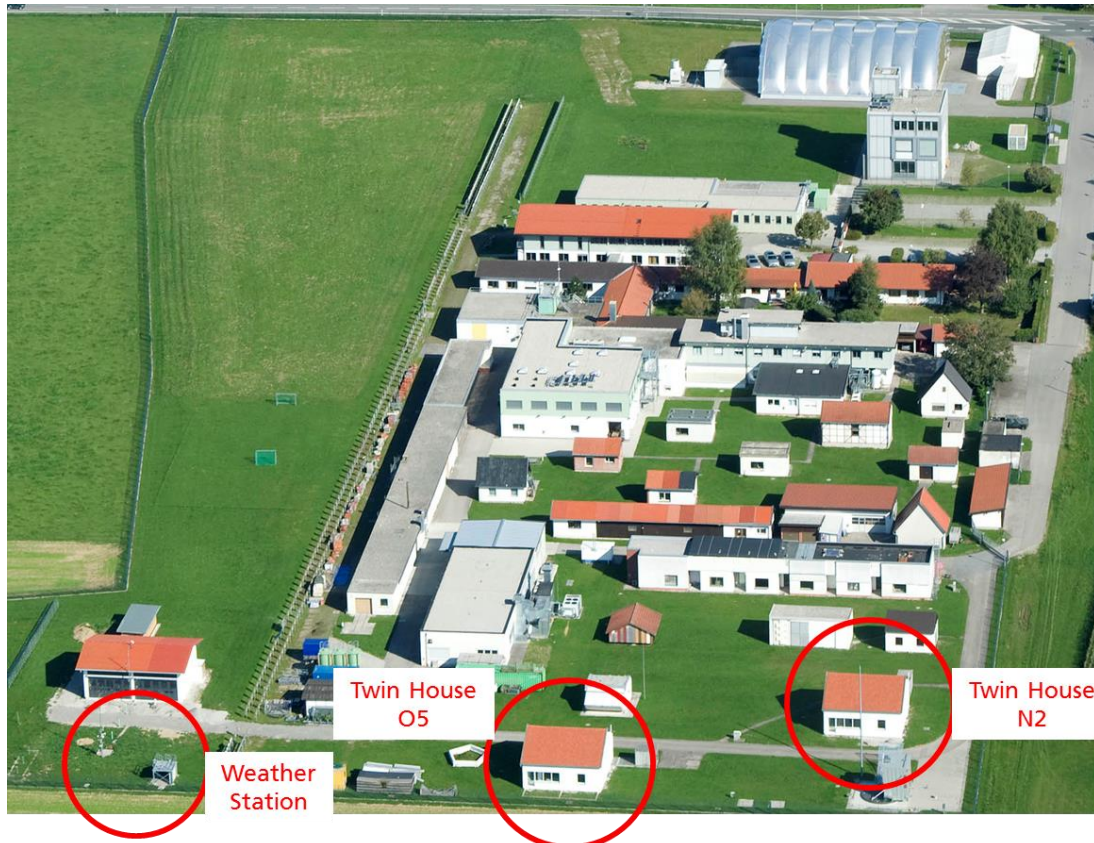

Figure 2: Location of Twin Houses in Holzkirchen, Germany.

All experimental data are publically available under:

<http://dx.doi.org/10.24406/fordatis/75> [1]

## 1.2. IEA EBC Annex 58

In the previous Annex 58 [2], two Building Energy Simulation program empirical validation experiments were undertaken [3]. The detailed specifications can be found here:

Experiment 1:

<http://dx.doi.org/10.15129/8a86bbbb-7be8-4a87-be76-0372985ea228> [4]

Experiment 2:

<http://dx.doi.org/10.15129/94559779-e781-4318-8842-80a2b1201668> [5]

A journal publication of the first experiment can be found here:

<https://doi.org/10.1080/19401493.2015.1064480> [6]

The first validation experiment was undertaken in August/September 2013 using both Twin Houses. A second validation experiment was undertaken on one of the twin houses (House O5) in cooler conditions (April/May 2014). The dataset collected in the second experiment was also designed to be useful as an Annex 58 common exercise for identification analysis.

### 1.3. Changes to Experimental Configuration for Annex 71 Experiment

The Building Energy Simulation (BES) model validation study, conducted during Annex 58 ([3], [6]) was designed to focus on the fabric-related functionality of BES programs including transmission heat losses, thermal bridges, solar gains, internal heat gains, window / blind models and internal and external air exchange. It did not consider occupancy user behaviour or typical heating and cooling systems. The following were deliberately not included in order to reduce complexity:

- No internal gains representative of occupants (heat, moisture and CO<sub>2</sub>)
- Constant set temperatures in constant temperature phases, no temperature profile or night setback
- Constant operation of a simple mechanical ventilation
- No opening of windows
- No operation of internal doors
- No building service equipment, just electrical heating.

The empirical model validation study of Annex 71 described in this specification increases the realism and complexity. Key aspects of the changes are as follows.

- Including building services equipment:
  - One of the Twin Houses (House O5: the test house) has an underfloor heating system supplied by an air source heat pump (Main Experiment only).
  - The other Twin House (House N2, the reference house), for comparison, has electrical heating as for the Annex 58 experiments.
- Inclusion of attic space in the experimental configuration in addition to the ground floor rooms that were the focus in Annex 58. The construction properties of the walls of the buildings have also changed, although these changes are small.
- Including synthetic occupancy profiles: it was considered too complex to monitor real occupants, so a realistic synthetic occupancy profile was developed for the various rooms in the house, including window and door opening in part of the experiment.
- Including moisture injections for assessing moisture buffering effects (Extended Experiment only).
- A “Main Experiment” consisting of a multi-stage operational schedule: a constant temperature phase (for coheating test assessment), a simple user 1 phase with a temperature profile consistent across all rooms, and a user 2 phase with a more complex user profile which varies from room to room and includes window and door opening. A second experiment, the “Extended Experiment”, included moisture injection of the synthetic users. This Extended Experiment consists of a user 3 phase, a phase with randomised heat injection (PRBS) and a free-floating period (incl. synthetic users).

The experimental design took into account that a too complex validation scenario would make it difficult for the modelling teams to identify the reason for deviations from the measurement data.



The experiment was also designed to be used as common exercises by the Annex 71 participants working with simplified models and methods of system identification. The datasets should be suitable for identification of building performance characteristics (ST3) and development of reduced order models useful for fault detection and model predictive control (ST2). These analyses may also provide useful information to explain differences between measurements and predictions from detailed modelling tools.

#### **1.4. Validation procedure**

This dataset can be used for many different purposes such as education and training, the development of simplified reduced order models and other scientific research requiring measurement data from well-specified real buildings. For these purposes usually the full dataset, containing all the data collected during the experiment, should be used. However when the focus is a BES model validation (and/or model development) it is recommended to follow the 2-phase blind/open validation approach (used in Annex 71), as described below, to separate user from program errors.

The model validation team predicts the temperatures and heating inputs using the program(s) under investigation. The validation methodology is a two phase blind validation, as used in Annex 58 [3] and similar to other previous IEA empirical validation studies. Ideally this procedure has different persons (or even organisations) working collaboratively to improve model quality assurance and analysis techniques. The required steps are as follows:

1. Blind validation (“blind phase”).
  - a. Modellers predict heating energy and indoor climate using the experimental specification, measured climate data and operational schedules but without knowledge of the measured heating energy consumption (in the case of known indoor climate) or indoor climate (in the case of known heating energy consumption).
  - b. Modellers submit their simulation results and a modelling report with details of the programs used and assumptions made.
2. Blind stage analysis. This compares predictions against experimental data for indoor climate and heat fluxes. Inevitably at this stage, differences are due to a mix of user / modelling errors and program deviations (and potentially measurement uncertainties).
3. Re-modelling (“open phase”). The measured data is disseminated. Modellers are encouraged to investigate differences between measurements and predictions and resubmit predictions and up-dated the report. Only changes which correct user modelling errors or alter a modelling assumption (with documented rationale) are allowed. It is important to ensure that model input parameters are not simply tuned to improve agreement with measurement. In principle, this step identifies program errors by eliminating modeller errors.
4. The improved predictions are compared against the measurements to identify remaining flaws and identify areas where program improvements are required. When complete, validation data sets and models are archived.

## 2. Experimental Design

Experimental design was undertaken to plan the test sequence that ensures the experiments are fit for purpose, i.e. in this case, they should provide a statistically robust dataset suitable for empirical validation of Building Energy Simulation (BES) programs. The aim is to test the ability of BES programs to predict the behaviour of the overall system based on the building and systems specification and measured boundary conditions.

Experimental design theory usually is based on being able to randomise and replicate. At the simplest level this involves altering each influencing factor one at a time, or changing a few factors in a defined scheme to determine interactions. However, for complex systems where there are multiple interactions between many different elements of the system, it is difficult (or perhaps impossible) to construct rigorous design of experiment strategies. A report by the American Physical Society (Energy Future: Think Efficiency [7]), characterizes the design of energy efficient buildings as a complex system. For example, internal temperatures are affected by solar gains, internal gains, radiant/convective split, wind-induced airflow, insulation levels, glazing properties, shading, window opening etc.

A pragmatic approach was therefore taken with the following elements:

- Determine the main influencing factors on performance; vary them through realistic range using the BES software EnergyPlus.
- Include random elements in the experiment which cover the range of conditions expected in real conditions. Regarding the weather, this means covering an extended period. For occupancy, it means making sure the magnitude and frequencies are realistic. A stochastic occupancy profile is used ([8], [9]).
- Include the most important user influences on a building: internal heat and moisture gains, operation of internal doors and external windows.
- Ensure the variable factors have a significant effect on the independent metric used. This could be temperature (e.g. in a free float period) or heat input to maintain a setpoint (e.g. in a discrete interval of constant temperature periods). This is checked by running BES on models of the Twin Houses using Test Reference Year climate data.
- Ensure all important influencing factors are measured to a sufficient level of accuracy. This was investigated through sensitivity analysis [10].
- Reduce measurement error through calibration of all instrumentation used and data checking.
- Fully document experimental specification and measurement.
- Use side-by-side experiments to focus on one or more important influencing factors (the degree of similarity between both Twin Houses and the experiment reflects the precision that can be derived from this side-by-side design; see baseline measurements in section 3.2).
- Use statistical measures of merit (power and confidence) to quantify discrepancy between model predictions and experiment.

- Use statistical analysis (e.g. regression analysis and calibration procedures) to determine possible reasons for deviations between simulation and experiment.

### **3. Experiment**

#### **3.1. Climate and location**

The houses are situated in a flat location at Holzkirchen, Germany (near Munich). The latitude of the buildings is 47.874 °N, the longitude is 11.728 °E. The elevation above mean sea level (MSL) is 680 m. Time of all data provided is in Central European (Winter) Time i.e. (UTC/GMT +1).

Information on the external shading can be found in the additional document under 02\_Additional Documents.zip\Geometry\External Shading\

Snow levels can provide additional shading especially on the living rooms' glass door. Data from the weather station's snow height sensor are included but note that increased wind speeds usually reduce the snow heights, particularly on the south and west facades.

#### **3.2. Baseline measurement**

##### *3.2.1 Air tightness*

To ensure comparable air tightness of both buildings a pressure difference test (blower door test) was conducted prior to the experiment. The test results are shown in

Table 1. As can be expected, the under-pressure tests show a lower tightness than the test conducted using overpressure. In particular, the operable window in the child1 room can be expected to be slightly pulled open by the under-pressure since it can't be locked fully (to allow the electric actuator to operate it). The overall buildings' mean air tightness values are  $0.87 \text{ h}^{-1}$  and  $1.10 \text{ h}^{-1}$  at 50 Pa pressure difference and both fulfil the requirements of the German building energy code of  $1.50 \text{ h}^{-1}$ . From the measured  $n_{50}$ -values infiltration air change rates of  $0.077 \text{ h}^{-1}$  and  $0.061 \text{ h}^{-1}$  respectively can be estimated in accordance with DIN V 18599-2 (E) [11], assuming 7 % of  $n_{50}$  as average infiltration. Together with the buildings' internal air volume of  $337 \text{ m}^3$  this means a difference of  $5.4 \text{ m}^3/\text{h}$ . Combining the mechanical ventilation of  $200 \text{ m}^3/\text{h}$  and the estimated mean infiltration of  $23.2 \text{ m}^3/\text{h}$  the absolute difference  $5.24 \text{ m}^3/\text{h}$  results in a relative difference in both buildings' air exchange of 2.4 %.

Table 1: Results of the Blower door test carried out on November 29, 2018.

Mean of over- and under-pressure test $n_{50}$ [ $h^{-1}$ ]		
	Test house (O5)	Reference house (N2)
entire building	1.10	0.87
ground floor	1.44	1.19
Result of overpressure test $n_{50}$ [ $h^{-1}$ ]		
	Test house (O5)	Reference house (N2)
entire building	1.06	0.80
ground floor	1.43	1.13
Result of under-pressure test $n_{50}$ [ $h^{-1}$ ]		
	Test house (O5)	Reference house (N2)
entire building	1.37	0.93
ground floor	1.45	1.26

### 3.2.2 Tracer Gas

After the end of the Extended Experiment in the O5 building the mechanical ventilation was deactivated and the outside air inlets and outlets were sealed. All doors and the trap door were opened and four air mixing fans were installed into the ground floor and the attic to ensure homogenous mixing of injected SF<sub>6</sub> within the Twin House's entire air volume.

On June 18<sup>th</sup> 7:00 and 19<sup>th</sup> 9:20 a SF<sub>6</sub> injection was done and the resulting decay was recorded until June 19<sup>th</sup> 2019 17:00. The measured concentrations, resampled to 10 minutes mean values, can be seen left in Figure 3. On the right side the resulting Air Change Rates (ACR) for all five sampling points inside the Twin House can be seen. This calculation was carried out according to DIN EN ISO 12569 [12]. Only 10 minute data with a decay in concentration between two data points were used.

The two seemingly high peaks of ACRs directly after the SF<sub>6</sub> injection, occurring mostly in the living and other ground floor rooms, are the result of the tracer gas dissipating to the other rooms of the Twin House. Filtering these two peaks, an average ACR of 0.04 h<sup>-1</sup> can be calculated for the entire O5 house. The ACR data can be found in "04\_Data\_Extended\_Experiment.zip\TracerEnd"; the associated climate period is included in the weather data provided for the Extended Experiment.

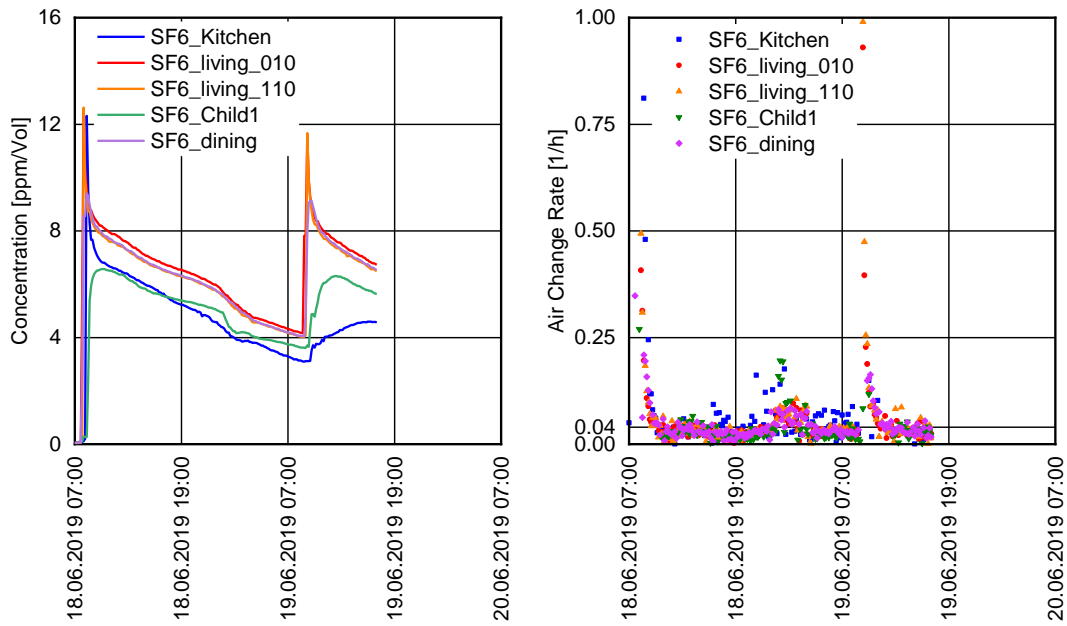

Figure 3: Measured SF<sub>6</sub> concentration (left) and resulting Air Change Rate (right) during the infiltration tracer gas experiment after the end of the Extended Experiment without mechanical ventilation.

### 3.2.3 Analysis of the coheating data

An analysis of the co-heating dataset was done by Alex Marshall and Richard Fitton from Salford University. The detailed report is included with the additional documents provided with this specification. This analysis found a Heat Transfer Coefficient of 103 W/K for the O5 building and 107 W/K for the N2 house (see Figure 4).

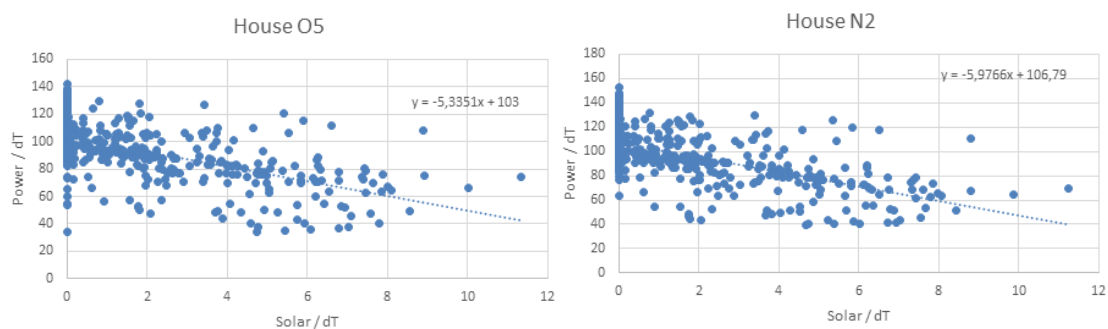

Figure 4: Regression analysis of the coheating data. Left for O5, right for N2.

To further investigate the difference between both houses their electric energy consumption during the coheating test were compared over a period of 12 days as a baseline measurement. Figure 5 shows the cumulative heating energy of both Twin Houses (red and blue line) and the cumulative deviation (black line). As can be seen in this figure after the 12 days the cumulative deviation between both Twin Houses has stabilized at a value of -4.25 %.

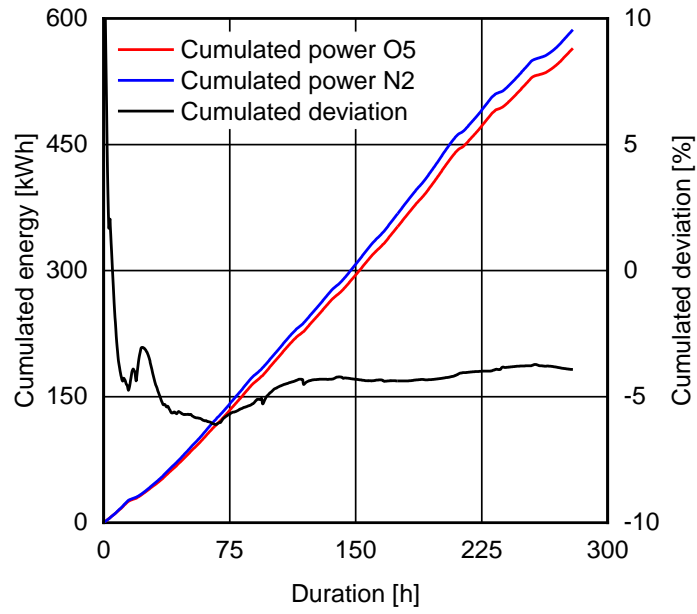

Figure 5: Baseline measurement conducted during the coheating test, conducted between 7<sup>th</sup> December 2018 18:00 and 19<sup>th</sup> December 2018 09:00.

### 3.3. Geometry

Detailed drawings with dimensions can be found among the additional documents:

- Plan attic.pdf
- Plan groundfloor.pdf
- section\_TwinHouses.pdf

Figure 6 and Figure 7 show an overview of the Twin Houses' geometry including the ventilation and door elements. The connection between both floors is a stair that is open in the living room on the ground floor and ends in a staircase in the attic from where doors lead to the childrens' rooms. This door can be sealed by a double trap door to create two separate air spaces for the ground floor and the attic.

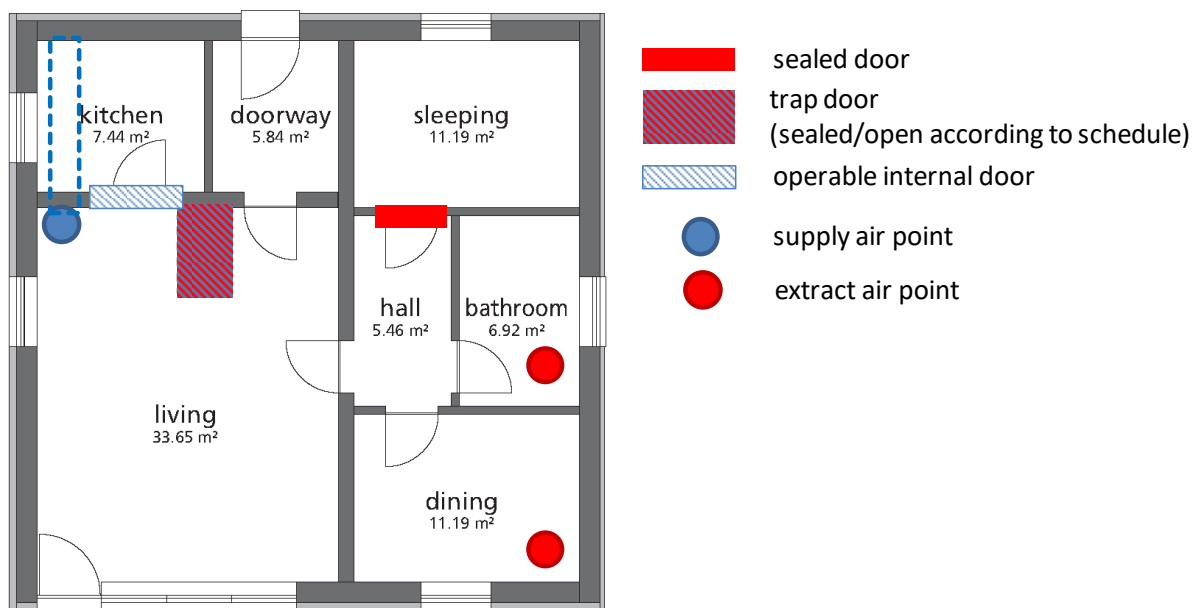

Figure 6: Floor plan ground floor.

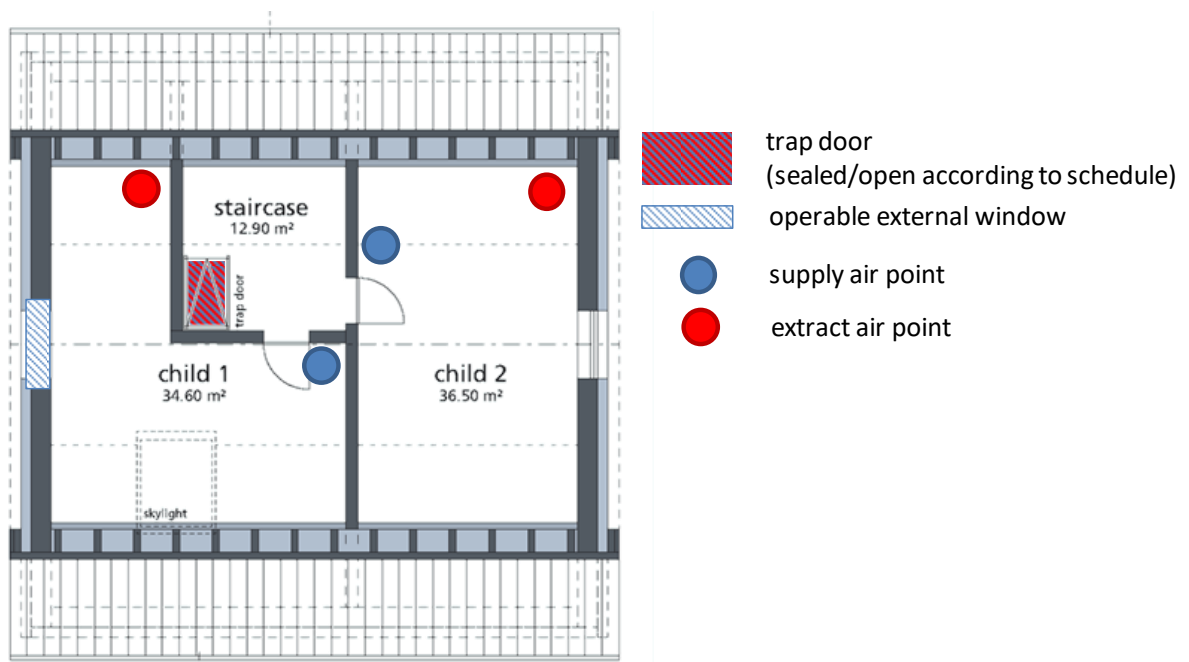

Figure 7: Floor plan attic.



Glazing configurations are shown in Figure 8.

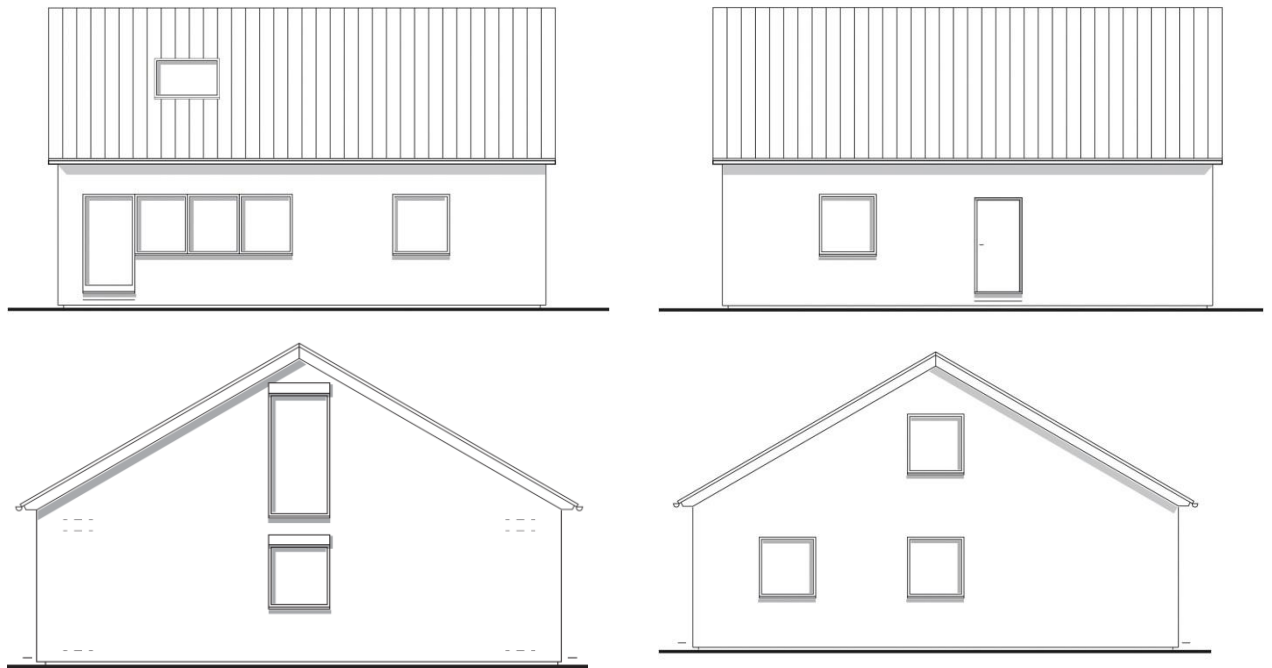

Figure 8: Twin House views: clockwise from top left: south, north, west, and east.

Details of the windows and glazing areas are given in Figure 9 and Table 2.

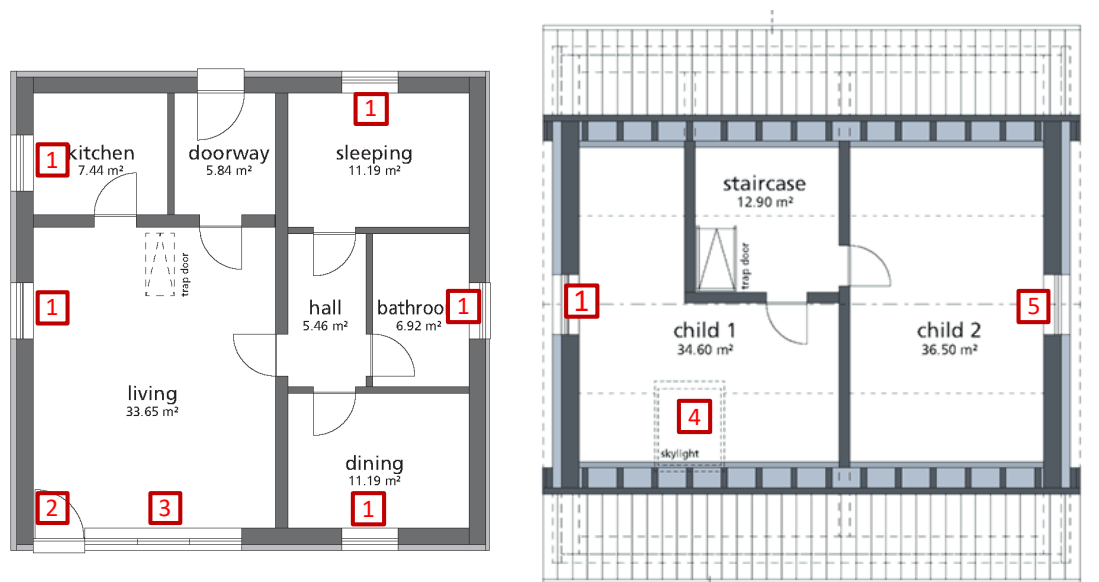

Figure 9: Overview of the window types. The window types are shown as red numbers.

Table 2: Specification of the window types' properties

Window type	Overall dimensions (including roller blind housing) [m <sup>2</sup> ]	Overall dimensions (excluding roller blind) [m <sup>2</sup> ]	Glass area without sealing strip [m <sup>2</sup> ]	Glass edge length [m]	Frame area [m <sup>2</sup> ]
1	1.74*1.23 = 2.14	1.54*1.23 = 1.89	1.30*0.99 = 1.29	4.62	0.60
2	2.57*1.11 = 2.85	2.37*1.11 = 2.63	2.13*0.865 = 1.84	6.04	0.79
3	1.74*3.34 = 5.81	1.54*3.34 = 5.14	3 panes, each 1.385*0.99 = 4.11 (total)	14.4	1.03
4	-	1.20*1.24 = 1.49	0.93*0.97 = 0.90	3.8	0.59
5	2.67*1.23 = 3.28	2.44*1.23 = 3.00	2.20*0.99 = 2.18	6.38	0.82

The ground floors' ceilings are supported by four concrete columns located in the living room, the dining room, the bedroom and the kitchen. Their geometry can be taken from Figure 10.

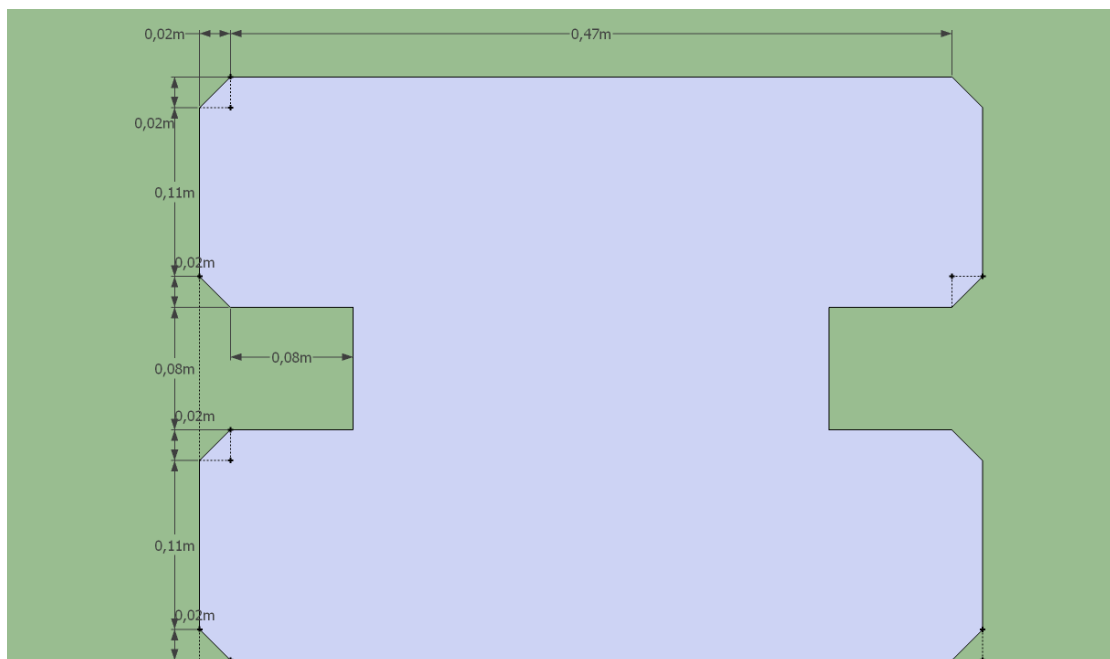

Figure 10: Geometry of the ground floors' four columns.

### 3.4. Constructions

The U-values of the constructions can be found in Table 3. The detailed constructions can be found in the additional documents in "01\_Constructions\_TwinHouses.xlsx"; "Humidity properties.pdf" contains an estimate for the moisture properties of the materials.

Table 3: U-values of the Twin Houses constructions.

Component		U-value (W/m <sup>2</sup> K)
Exterior Wall	West	0.24
	East	0.24
	<u>South:</u>	
	ground floor	0.21
	railing main window	0.25
	knee wall 2 <sup>nd</sup> floor	0.28
	North	
	ground floor	0.21
	knee wall 2 <sup>nd</sup> floor	0.29
Ceiling	Currently not insulated	0.51
Floor		0.29
Roof		0.22
Window		1.20
Front door		0.94

Absorptivity of the internal wall and ceiling surfaces was not measured before the experiment. As in Annex 58 these surfaces were painted directly before the experiment with the same colour and type of paint. The value measured in Annex 58 could be a good assumption. "Absorptivity of the white painted internal plaster was measured as 0.17." [3]. During the same experiment the absorptivity of the external walls was measured as 0.23.

### 3.4.1 Internal doors

The internal doors (Figure 11) have a height of 2.00 m and a width of 0.95 m. The material is wooden honeycomb board with a thickness of 4 cm with a single pane glazed area of 38.0 x 64.5 cm. The ventilation slots near the base of the doors are tape sealed. The bottom gap is about 2 mm on average. As shown in section 3.3 all internal doors are open except for the sleeping rooms' doors (permanently closed; not sealed), the kitchen door (acc. to section 4 operated in some phases) and the trap door between ground floor and attic space (open/closed during some phases as described in section 4).



Figure 11: Internal door.

### 3.4.2 Trap door

The trap door between the ground floor and attic is 1.39 x 0.57 m. The door leaves are massive wood with 4 cm for the upper and 2 cm for the lower leaf. Both have a 4-sided rubber seal. The horizontal air layer between the two leaves is 34.5 cm. For the Extended Experiment the attic doors' positions are added to the measurement data as "n2\_attic\_door\_pos" and "o5\_attic\_door\_pos".

### 3.5. Glazing optical and thermal properties

The glazing is double glazing with low emissivity coating and argon fill. Layers are (outside to inside):

Interpane Clear float 4mm

Gas fill 16mm (90% argon, 10% air)

Interpane Iplus E 4mm inner pane

The window U-value (following EN ISO 10077-1) is 1.2 W/m<sup>2</sup>K for all windows in the façade. The  $\psi$  -value of the glass edge is 0.05 W/mK. The glass U-value is 1.1 W/m<sup>2</sup>K and the frame U-value is 1.0 W/m<sup>2</sup>K.

Window 6.3 was used to obtain the optical properties of the glazing by selecting the glazing panes from the International Glazing Database [13] and using EN 673 boundary conditions. Table 4 and Table 5 give the angular dependent properties for both NFRC and EN 410 spectra.

Table 4: Glazing optical properties: NFRC

Angle	0	10	20	30	40	50	60	70	80	90	Hemis
Visible transmittance	0.803	0.807	0.796	0.782	0.762	0.722	0.632	0.459	0.214	0	0.671
Solar transmittance	0.512	0.515	0.508	0.498	0.484	0.458	0.401	0.293	0.136	0	0.427
Reflectance (front)	0.292	0.287	0.285	0.286	0.293	0.31	0.351	0.448	0.644	1	0.338
Reflectance (back)	0.281	0.275	0.273	0.275	0.285	0.303	0.34	0.423	0.611	0.999	0.325
Absorptance outer layer	0.112	0.112	0.114	0.117	0.122	0.127	0.133	0.137	0.132	0	0.123
Absorptance inner layer	0.084	0.086	0.093	0.098	0.1	0.104	0.115	0.123	0.087	0	0.102
SHGC	0.571	0.575	0.572	0.566	0.554	0.531	0.481	0.378	0.197	0	0.497

Table 5: Glazing optical properties: EN410

Angle	0	10	20	30	40	50	60	70	80	90	Hemis
Visible transmittance	0.803	0.808	0.797	0.782	0.762	0.722	0.632	0.459	0.214	0	0.671
Solar transmittance	0.543	0.546	0.538	0.528	0.514	0.486	0.426	0.310	0.145	0	0.452
Reflectance (front)	0.264	0.260	0.258	0.259	0.267	0.286	0.329	0.433	0.640	1	0.315
Reflectance (back)	0.255	0.249	0.247	0.249	0.260	0.279	0.317	0.404	0.599	0.999	0.302
Absorptance outer layer	0.107	0.108	0.109	0.112	0.116	0.121	0.126	0.130	0.124	0	0.118
Absorptance inner layer	0.085	0.087	0.094	0.100	0.102	0.106	0.119	0.127	0.091	0	0.104
SHGC	0.602	0.606	0.604	0.598	0.585	0.560	0.508	0.398	0.208	0	0.525

The glazing supplier (Interpane) has quoted figures for the glazing normal incidence properties that conform to those in Table 5 with the exception that they quote the solar heat gain coefficient as 0.62.

To prevent driving rain from being blown into the building during this automated experiment the external windows (see Figure 12) can only tilt but not swing fully open. The upper part of the window is tilted inward for 14.3 cm while the bottom is not moved, so the two side openings form a triangle, with a rectangular shape on the top.



Figure 12: Operated external window in tilted position.

### 3.6. Roller blinds

Details are shown in Figure 13. The roller blind absorptivity was measured by Fraunhofer IBP as 0.32. The geometry of the roller blind slats can be found in the supplementary file "Rollerblinds.zip". The air gap between the glazing and the blind is 59 mm ( $\pm 2$  mm) and 23 mm ( $\pm 1$  mm) for the three (not openable) glazings beside the living room glass doors. The living rooms' roller blinds on the west façades were closed during the entire experiment; the kitchens' roller blinds were closed at the start of the user-2 phase.



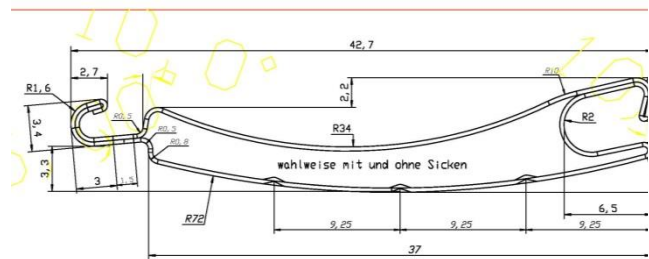

Figure 13: Details of roller blinds.



### 3.7. Thermal bridges

The following thermal bridge  $\psi$  –values were obtained with HEAT2.

#### Wall – Ceiling joint

The wall – ceiling joint is shown in Figure 14 (solution with 70 mm insulation).

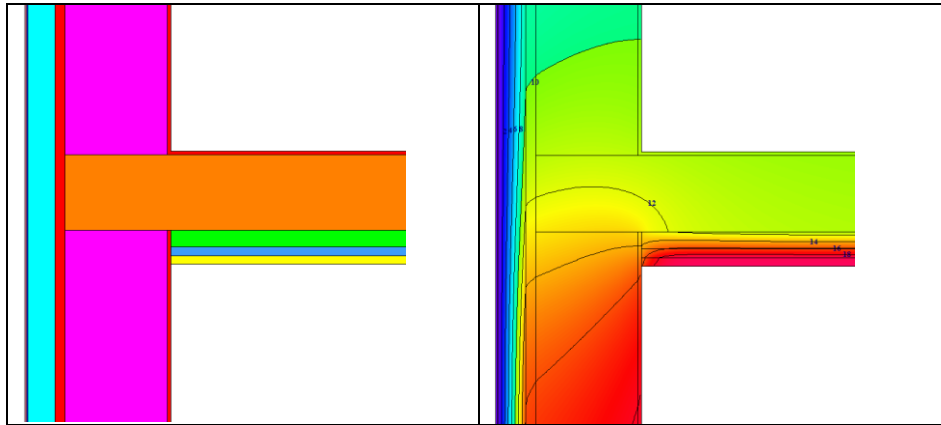

Figure 14: Wall – ceiling joint with 80 mm insulation. Model and temperatures.

Since there are three different temperatures in the calculation the linear thermal transmittance will be dependent on temperature. In the following it is assumed that the indoor temperature is 20 °C, the outdoor temperature is 0 °C and the attic temperature is 10 °C. Table 6 presents the results.

Please note: This thermal bridge contains losses to the outside AND the attic. The combined losses from ground floor and attic to the outside can be found in Table 11. This detail models the gable wall joint to the ceiling on the east and west sides of the Twin Houses. The knee walls' joint to the ceiling on the north and south can be found in Table 11 as "TM-06".

Table 6: Linear thermal transmittance for wall – ceiling joint in W/mK.

	External measurements	Internal measurements
70 mm insulation (east wall)	0,383	0,542
120 mm insulation (north, south, west)	0,370	0,536

Alternatively, the linear thermal transmittance is split in two, i.e. linear thermal transmittance from room to outside and linear thermal transmittance from room to attic as can be seen in Table 7.

Table 7: Linear thermal transmittances for wall – ceiling joint in W/mK.

	External measurements		Internal measurements	
	$\Psi_{io}$	$\Psi_{ia}$	$\Psi_{io}$	$\Psi_{ia}$
70 mm insulation (east wall)	0.121	0.509	0.194	0.696
120 mm insulation (north, south, west)	0.115	0.511	0.187	0.699

### Wall – Wall joint

The wall – wall joint is shown in Figure 15 (solution with 70 mm insulation).

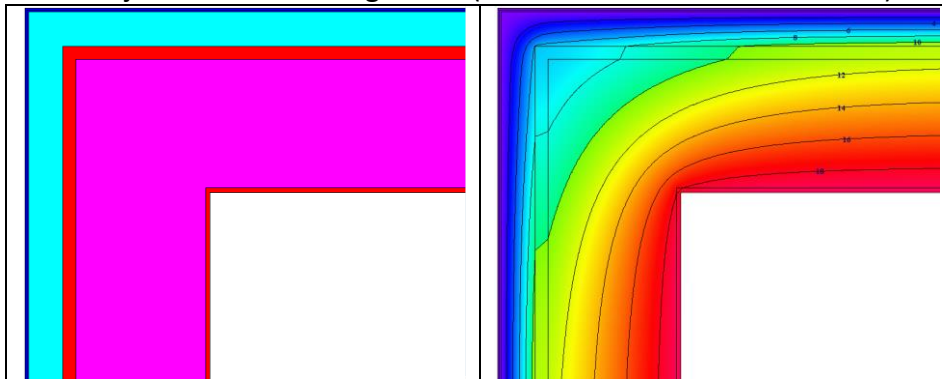

Figure 15: Wall – wall joint with 70 mm insulation. Model and temperatures.

Table 8 presents the results.

Table 8: Linear thermal transmittance for wall – wall joint in W/mK.

	External measurements	Internal measurements
70 mm insulation <ul style="list-style-type: none"> <li>• South-east</li> <li>• North-east</li> </ul>	-0,095	0,095
120 mm insulation <ul style="list-style-type: none"> <li>• South-west</li> <li>• North-west</li> </ul>	-0,110	0,095

## Wall – Floor joint

The wall – floor joint is shown in Figure 16 (solution with 70 mm insulation).

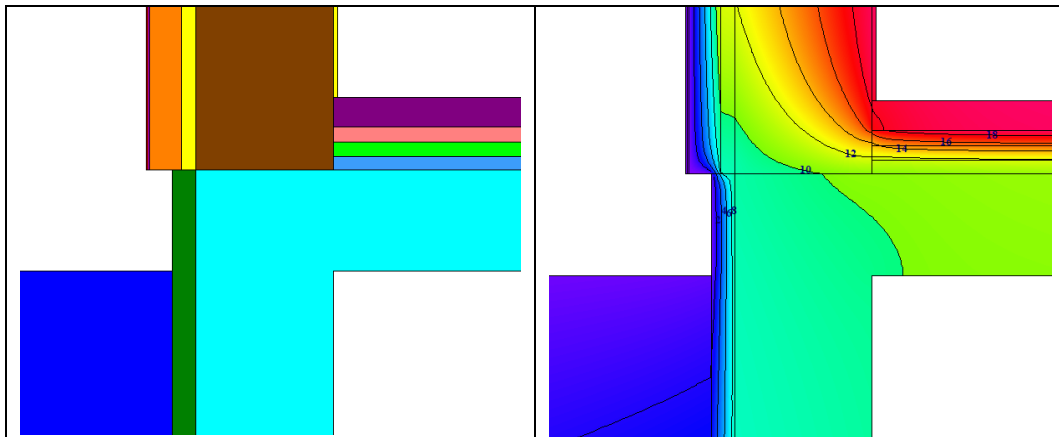

Figure 16: Wall – floor joint with 70 mm insulation. Model and temperatures.

As with the wall – ceiling joint there are three different temperatures in the calculation. In the following it is assumed that the indoor temperature is 20 °C, the outdoor temperature is 0 °C and the basement temperature is 10 °C. Table 9 presents the results.

Table 9: Linear thermal transmittance for wall – floor joint in W/mK.

	External measurements	Internal measurements
70 mm insulation (east wall)	-0,036	0,108
120 mm insulation (north, south, west)	-0,038	0,111

Again, the linear thermal transmittance is split in two, i.e. linear thermal transmittance from room to outside and linear thermal transmittance from room to basement (see Table 10).

Table 10: Linear thermal transmittances for wall – floor joint in W/mK.

	External measurements		Internal measurements	
	$\Psi_{io}$	$\Psi_{ib}$	$\Psi_{io}$	$\Psi_{ib}$
70 mm insulation (east wall)	-0.064	0.045	0.020	0.177
120 mm insulation (north, south, west)	-0.059	0.044	0.023	0.176

The external thermal bridge  $\psi$  –values shown in Table 11 have been obtained with TRISCO. For a better understanding Figure 17 gives an overview of the names for roof components.

Table 11: Thermal bridges of the Twin Houses.

Model:		position	$U_e$ :	$\Psi_{ext}$ :	$\Psi_{int}$ :	$\chi$ :
TM-01	Ridge junction			-0.009	0,006	
TM-02	Rake Junction- Mineral wool	Junction between roof and external wall west		0.043	0.188	
TM-03	Rake Junction- Polyurethane	Junction between roof and external wall east		0.051	0.186	
TM-04	Eaves Junction- Combined	between roof / south and north knee walls		-0.015	0.165	
TM-05	Eaves Junction, isolated			0.070	0,181	
TM-06	Ceiling-wall junction ( <i>knee walls</i> )			0.022		
TM-07	Column - Floor					0.656
TM-08	Column - Ceiling					0.643
TM-10	Internal wall, thin - Ceiling			0.047		
TM-11	Internal wall, thin - Floor			0.239		
TM-12	Internal wall, thick - Ceiling			0.045		
TM-13	Internal wall, thick - Floor			0.331		
TM-14	Window Jamb - brick wall, Wood fibre insulation	applies to windows in south and north walls		0,037		
TM-15	Window Lintel - brick wall, Wood fibre insulation	applies to windows in south and north walls		0,039		
TM-16	Window Sill - brick wall, Wood fibre insulation	applies to windows in south and north walls		0,034		
TM-17	Window Jamb - brick wall, Mineral wool insulation	applies to windows in west wall		0,038		
TM-18	Window Lintel - brick wall, Mineral wool insulation	applies to windows in west wall		0,040		
TM-19	Window Sill - brick wall, Mineral wool insulation	applies to windows in west wall		0,035		
TM-20	Window Jamb - brick wall, Polyurethane insulation	applies to windows in east wall		0,029		
TM-21	Window Lintel - brick wall, Polyurethane insulation	applies to windows in east wall		0,032		
TM-22	Window Sill - brick wall, Polyurethane insulation	applies to windows in east wall		0,027		
TM-23	Trapdoor - Ceiling			0.054		

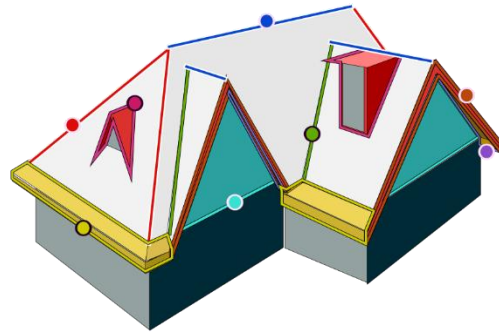

- Rakes      ■ Ridge      ■ Soffit      ■ Eaves
- Dormer    ■ Gables    ■ Valleys    ■ Hip

Figure 17 : Naming of a roof's components [14].

### 3.8. Ventilation

As in Annex 58 this experiment mainly uses mechanical ventilation because the resulting mass and energy flows can be measured much better than the air exchange caused by an open external window. Despite this experimental difficulty, opening windows are an essential part of user behaviour and will be included in part of the experiment (see section 3.15.6). As typical for a residential situation the ventilation system operates based on a target constant air change rate of  $0.6 \text{ h}^{-1}$ . The total supply and exhaust air volume for the entire building is measured and precisely PLC controlled, separately for ground floor and attic. The instrumentation gives the volume flow rate corrected to standard temperature and pressure (1013.25 hPa and  $20 \text{ }^\circ\text{C}$ ). To convert that signal into a mass flow rate, the air properties at sea level must be used. The air density at sea level and at  $20 \text{ }^\circ\text{C}$  is  $1.204 \text{ kg/m}^3$ . To calculate the ventilation mass flow rate (kg/s) the measured volume flow rate ( $\text{m}^3/\text{s}$ ) must be multiplied by  $1.204 \text{ kg/m}^3$ .

The rooms' individual air volume share is adjusted using disc valves once during the experiment's setup. So the room air volumes can vary caused by changes to the pressure regime and are not controlled to be constant. The rooms' individual ventilation air flow rates and temperatures are measured. Since a multi-room tracer gas measurement is part of this experiment the number of air bodies, separated by (sealed) doors, was limited. As Figure 18 and Figure 19 show, the experiment has four separate air bodies (Table 12). Table 13 specifies the set volume flows of the mechanical ventilation system. In some extreme winter conditions (e.g. morning of 1<sup>st</sup> of January) the external ventilation inlets were cloaked by ice and cause reductions from the set values until they were de-iced. However, the measured flow rates are given as input data so this information can be included in the model. The supply air duct to the living room runs through the kitchen, the bath exhaust air duct runs through the dining room and all ducts concerning the childrens' room run through the stairs. These ducts are insulated with 20 mm aluminium laminated mineral wool.

Table 12:

Air bodies of the experiment (not considering the air space in the door frames).

Air body	Rooms	Floor Area [m <sup>2</sup> ]	Volume [m <sup>3</sup> ]
Ground	living, corridor, bath, dining, doorway	63.06	164.00
Kitchen	kitchen	7.44	19.34
Sleeping	sleeping (north)	11.19	29.09
Attic	child 1, child 2, staircase	84.06	151.72
Total	all rooms	165.75	364.15

Table 13: Resulting air flows.

Location	Type	Flow [m <sup>3</sup> /h]
Living room	Supply	100
Bathroom	Exhaust	50
Dining	Exhaust	50
Child1 and Child2	Supply and Exhaust	50

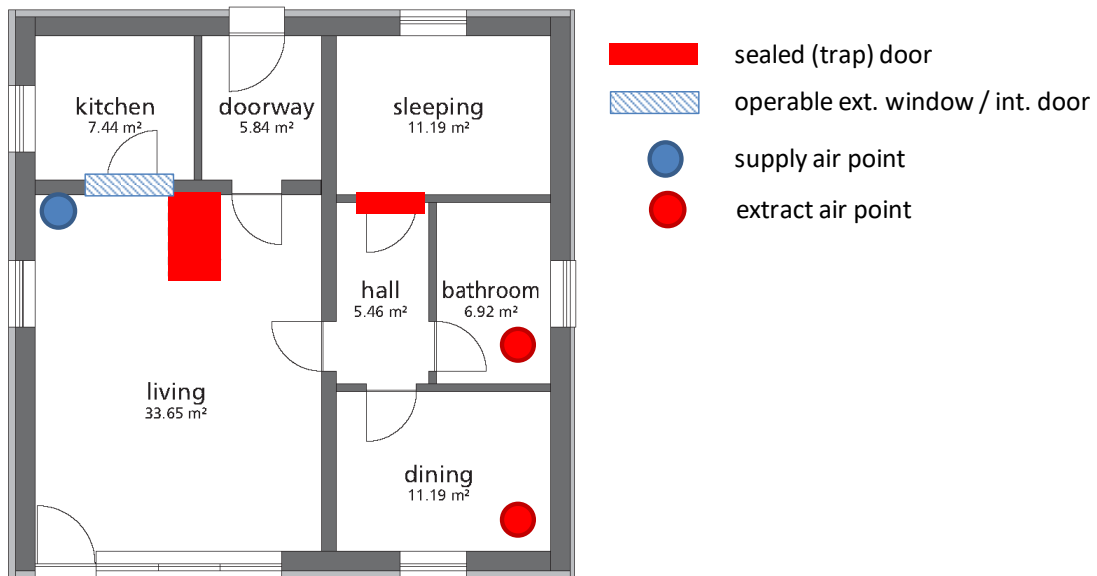

Figure 18: Floor plan ground floor.

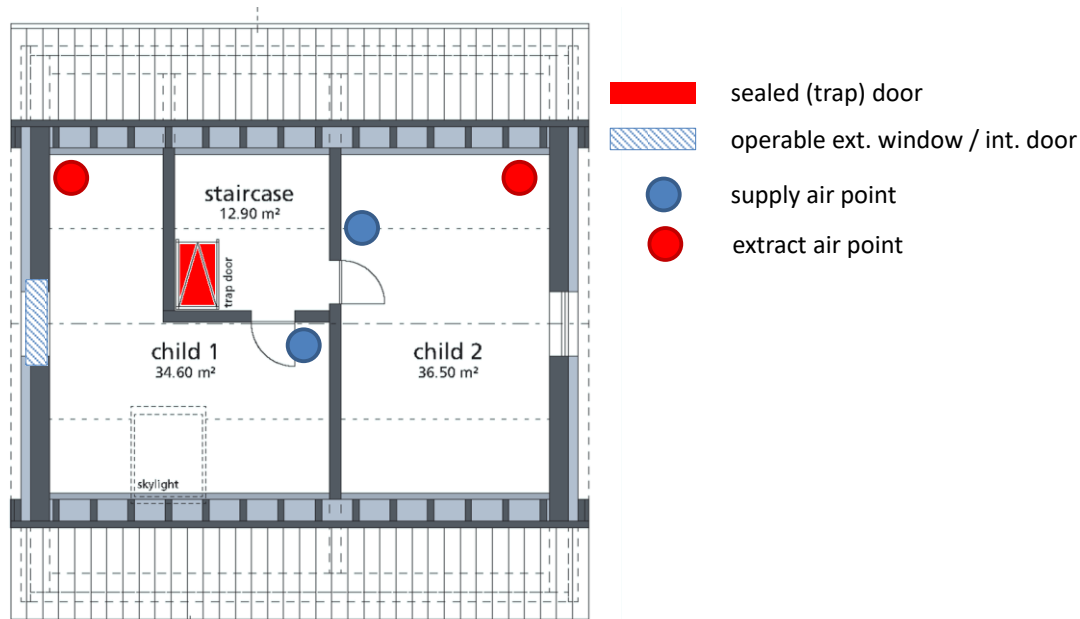

Figure 19: Floor plan attic.

### 3.9. Heating / cooling

Cooling is not part of this experiment. The Twin Houses were configured to have a side-by-side measurement of two different heating systems during the Main Experiment and to investigate the effects of moisture loads during the Extended Experiment.

- Reference Building (N2): Electrical
- Test Building (O5): Underfloor heating with air source heat pump (Main experiment) or moisture loads (Extended experiment)

The corridor, doorway and stairs were unheated (after the coheating phase).

### 3.10. Electrical heating (N2 house)

The electric heaters were power controlled to keep the set temperatures in the rooms. This was realized through a PI controller, integrated into the Twin House PLC. The power consumption in every room was measured. The heaters used were Dimplex AKO K 810/K 811 (Figure 20). The manufacturer gives the radiative / convective split as 30 % / 70 %. The heaters were lightweight with a fast response – estimated as 1 or 2 minutes by Fraunhofer IBP. Details of the heaters used are given in Figure 21. In each room one heater is located as can be seen in Figure 22. The kitchen and bathroom of the N2-house have a separate second electrical heater to separate the relatively high internal heat sources (IHS) from the heating power.

These heaters' power output is controlled by a PI controller (implemented into the Twin Houses' PLC) with a proportional gain of 4 and an integration time of 5 Minutes. The individual rooms' air temperature sensors at 110 cm are used for control.

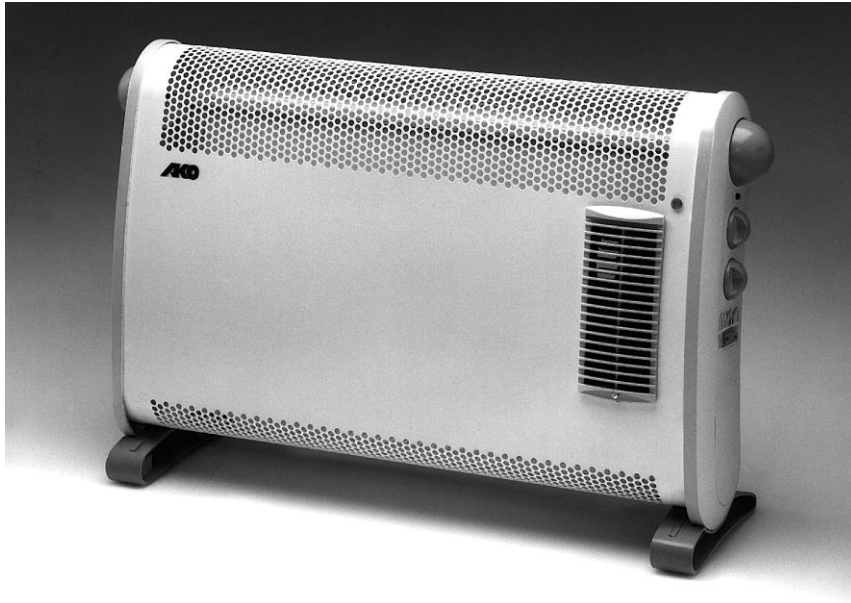

Figure 20: Electric heater.

Technical specifications		
Convector	K 810	K 820
Nominal voltage	230V~ / 50 Hz	
Power	750 / 1250 / 2000 W	
Switched levels	- 1 (OUT) - 2 (750 W) - 3 (1250 W) - MAX (2000 W) Thermostat with frost protection function	- 1 (OUT) - 2 (750 W) - 3 (1250 W) - MAX (2000 W) Thermostat with frost protection function - Fans
Protection class	I	
Approx. dimensions (W x H x D)	70 cm x 45 cm x 15 cm	
Approx. weight	4,0 kg	

## 2. Technical data

Heat output: 2000 W  
 Connection voltage: 1/N/PE~, 230 - 240 V, 50 Hz  
 Protection type: IP20  
 Protection class: I (with protective conductor)  
 Dimensions:  
 free-standing (W x H x D) 575 x 418 x 200 mm  
 wall-mounted (W x H x D) 575 x 345 x 120 mm  
 Weight: 3.5 kg (K 811), 4.1 kg (K 821)

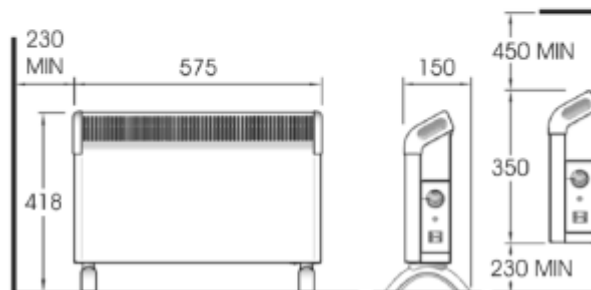

Figure 21: Heater specifications.



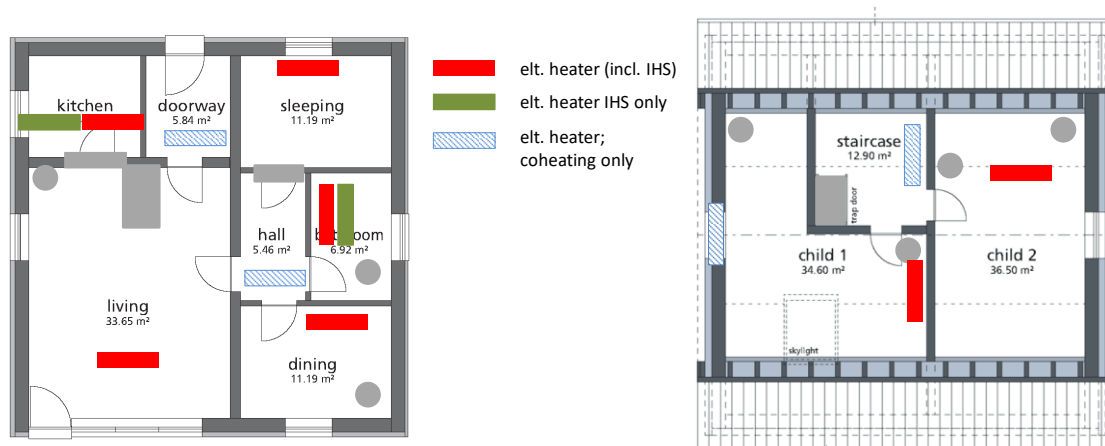

Figure 22: Heater layout.

The temperature in all rooms is controlled by the shielded air temperature sensor at the mid-height of the room (110 cm).

### 3.11. Heat pump (O5 house)

The air source heat pump is an “aroTHERM VWL 55/2 A” (see Figure 23 and Table 14) from the manufacturer Vaillant. The heat pump’s internal controls were used. The electrical consumption and fluid temperatures and flow rate were measured on the secondary side. This system comprises a 4.9 kW heat pump with a COP of 2.40 and an additional 6 kW direct heating. The COP for domestic hot water is 1.80. The system switches its compressor’s set point between heating- and DHW-mode. The underfloor heating is designed for 35 °C supply temperature. In heating mode, the heat pump feeds directly into the underfloor heating system; the 300 litre tank is for DHW buffering only.

See “arotherm-vwl-55-85-115-155-2-datenblaetter-1115125.pdf” in the additional documents.

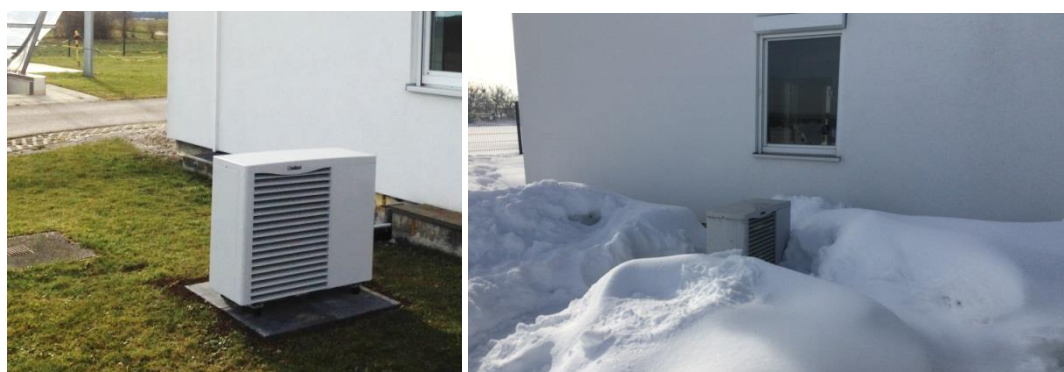

Figure 23: External installation of the Twin Houses Vaillant “aroTHERM VWL 55/2 A” air source heat pump, left in summer, right in winter.

Table 14: Technical specifications (COP) of the heat pump Vaillant aroTHERM VWL 55/2 A

Outside air temperature [°C]	Supply water temperature [°C]		
	35	45	55
-15	2.3	1.9	*
-7	2.4	2.3	1.8
2	3.1 ( $\Delta t = 5$ K)	2.9 ( $\Delta t = 5$ K)	3.0 ( $\Delta t = 8$ K)
7	4.7 ( $\Delta t = 8$ K)	3.4 ( $\Delta t = 8$ K)	2.7 ( $\Delta t = 8$ K)
10	5.0	3.8	3.0
12	3.0	4.0	3.2

\* outside envelope of performance chart.

<https://www.vaillant.de/heizung/produkte/luft-wasser-waermepumpe-arotherm-704.html>

### 3.12. Domestic Hot Water (O5 house)

During the user 1 phase DHW is only of importance for the O5 Twin House which is heated by the heat pump. A 300 litre DHW buffer vessel is connected to the heat pump. Attached to this buffer is a PLC controlled system that allows drawing defined DHW amounts in terms of energy. The DHW valve is opened until the amount heat defined by the current energy per draw is reached.

The drawn DHW was drained directly out of the building. The entire DHW installation is located in the cellar and there is no DHW circulation. Therefore all internal heat and moisture gains resulting from DHW are in the cellar and do not influence the ground floor and attic spaces which are the focus for the validation experiment. The heat pump alternates between heating and DHW production while DHW has the priority option. The air temperatures in the cellars are recorded as boundary conditions. Therefore the hot water draw will only be of interest to modelling teams who are modelling the heat pump. The measured data includes the flow rates and supply temperature to the underfloor heating system - this can be used by modellers who are not including a model of the heat pump.

### 3.13. Underfloor heating (O5)

The floors of the Twin Houses (both ground floor and attic floor) are equipped with a hydronic underfloor heating system. These systems are supplied by the heat pump. The room temperatures are controlled by the Twin Houses' PLC via a 2-point (on/off) controller with a 1 K hysteresis ( $\pm 0.5$  K) as is typical for a floor heating system. The individual rooms' air temperature sensors at 110 cm are used for control. The underfloor heating is designed for 35 °C supply temperature but the real supply temperature was set by the weather-compensated heating curve.

The underfloor heating was used in the O5 house only.

In the ground floor the piping is installed in a counterflow system (spiral shape) with spacing of 10 cm in a wet screed system. Logafix PE-RT 17 x 2.0 mm is used (nominal internal diameter 17 mm and pipe thickness 2 mm). The attics' piping of the dry screed system has a spacing of 15 cm in a serpentine installation with heat transfer aluminium profiles. The pipe material is a ROTO Alu-Laserflex 14 x 2.2 mm (nominal internal diameter 14mm and pipe thickness 2.2 mm). These installations can be seen in Figure 24.

Table 15: Overview of the ground floor underfloor heating.

No.	room	ground floor				
		[m <sup>2</sup> ]	piping [m]	through living [m]	through corridor [m]	[m/m <sup>2</sup> ]
1	doorway	5,9	56	6	4	9,5
2	kitchen	7,5	59	11	3	7,9
3	living (3 circuits)	33,6	309	-	24	9,7
4	dining	11,1	97	-	10	8,8
5	bath	6,2	59	-	8	9,5
6	bed	12,2	110	-	4	9,1
7	corridor <i>(not circuit, just pipes from other rooms to the distribution)</i>	4,8	53	-	(53)	11,1
sum		81,2	743,0	17	53	
No.	room	attic				
		[m <sup>2</sup> ]	piping [m]		through staircase [m]	[m/m <sup>2</sup> ]
2	child1 (3 circuits)	34,7	77+72+71	-	3	6,3
3	child2 (3 circuits)	36,8	81+81+84	-	3	6,7
sum		71,5	466,0		6	



Figure 24: Spiral pipes of the dining room in the ground floors (left) and the child 2 rooms' serpentine pipes in the attics' (right) underfloor heating during installation.

### 3.14. Hydronic Scheme

The hydronic scheme for the heat and DHW installation (including instrumentation) of the Test House O5 is shown in Figure 25. A higher resolution diagram is included in the additional documents.

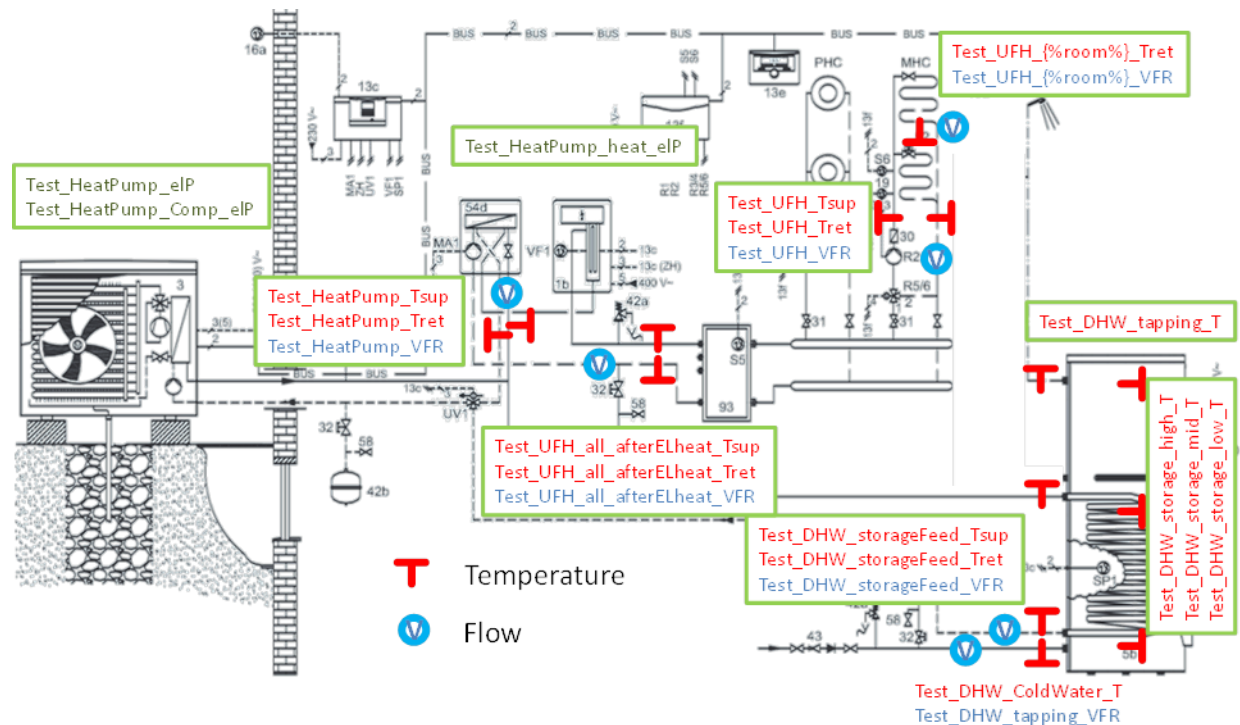

Figure 25: Hydronic scheme of the Test House O5's heat and DHW installation including the instrumentation.

### 3.15. Synthetic user

The validation specification of Annex 71 also includes realistic occupancy profiles. Occupying the Twin Houses with real humans would bring some disadvantages for the experiment because there would be large uncertainties regarding their room-wise occupancy and the magnitude of the occurring internal loads (heat, moisture and CO<sub>2</sub>) caused by them. Also real users always bring internal humidity sources to the building that should not be present during the first parts of the experimental schedule to keep these parts of the validation simpler. To avoid this, "synthetic users" were used in this validation experiment. This means that a typical room-wise usage profile was developed. From this, occupancy profiles synchronized to the internal load profiles were derived.

These profiles are required for the following experimental phases (see section 4):

- User phase
- Free floating phase
- Controlled moisture phase
- Free moisture phase

### 3.15.1 Occupancy

The occupancy profiles used in this experiment are simulated profiles for a family with two children. The simulation model used is based on time use survey data [8] [9]. This means that the data have a stochastic element and are different for every day. Figure 26 shows two example days of this dataset. These occupancy data are provided as a time series dataset.

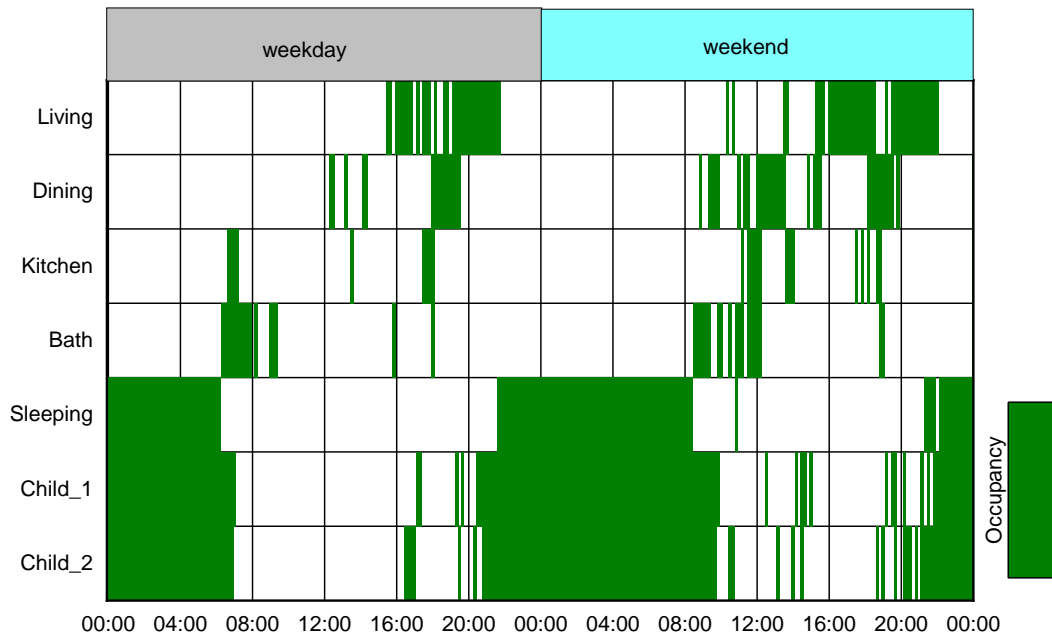

Figure 26: Typical occupancy profiles for two days.

### 3.15.2 Internal heat sources

A profile for the internal heat loads, caused by the occupants, their usage of appliances and artificial lighting has been derived from the occupancy profiles. The heat loads were injected into the rooms by the same electrical convectors as described in Section 3.10. Figure 27 shows two example days of this dataset. These occupancy data are provided as a time series dataset. Figure 28 gives an overview of the buildings' total heat gains during the entire test period.

In the case of electric heating, internal heat gains and additional heating inputs are provided as separate inputs. For the kitchen and the bathroom, the internal heat gains and additional heating inputs are measured separately and are provided by separate convectors. For the living room, bedroom and the childrens' rooms this is a calculated split based on the internal heat gain scheduled values. The dining room has heating only (no internal heat gains); the corridor has only internal heat gains; doorway and stairs have no heat input after the coheating phase. The O5 corridor has an additional constant heat input of  $12 \times 2.4$  W through the under floor heating's flow meters. The O5s' children rooms hold one flow meter each.

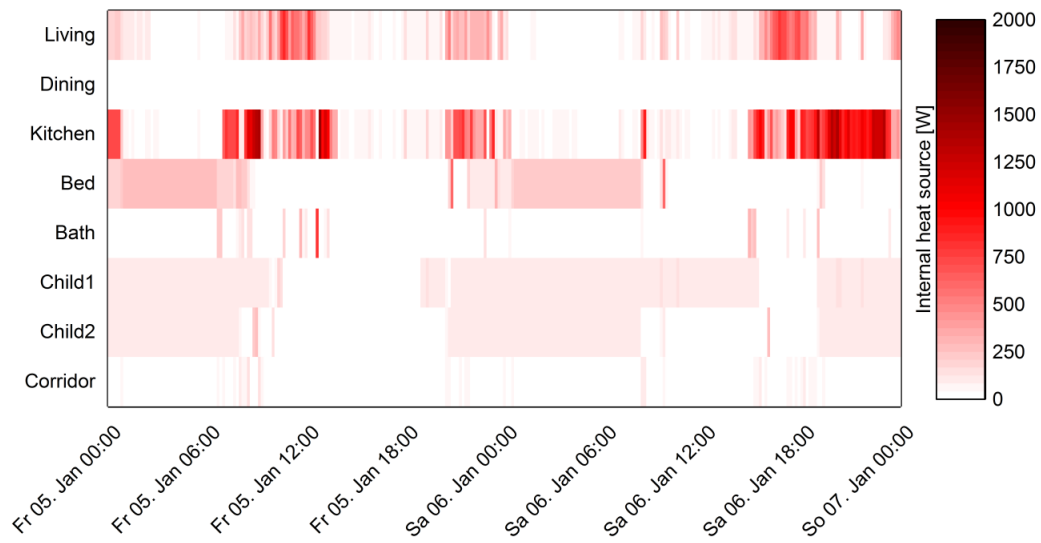

Figure 27: Resulting internal heat gains for two example days.

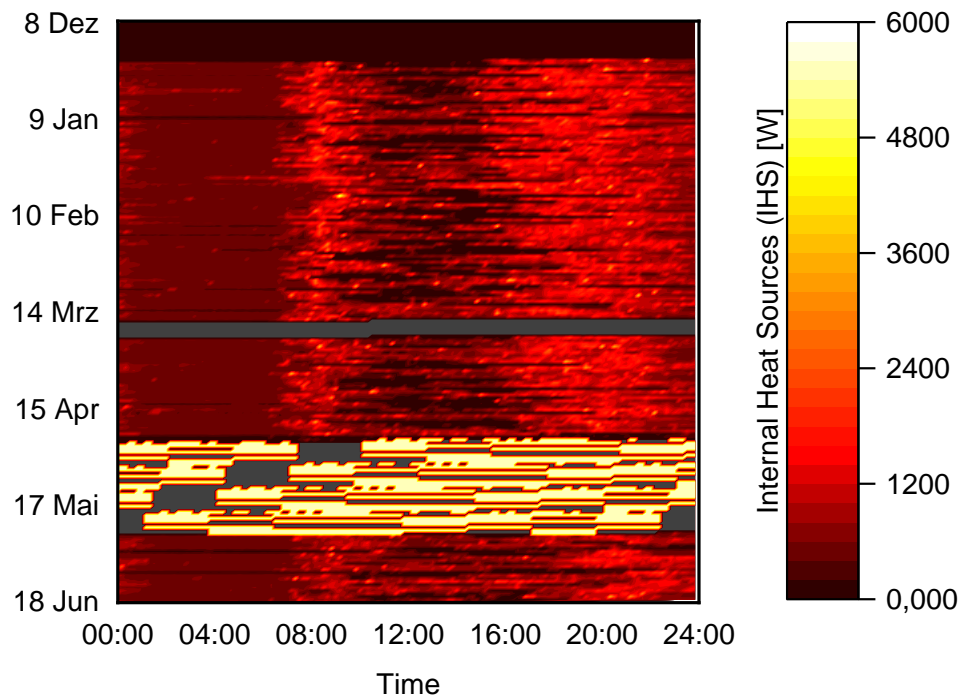

Figure 28: Overview of the internal heat gains for the entire building for the complete test period. The bright, yellow section in April/May is the PRBS.

### 3.15.3 Internal humidity sources

In the Extended Experiment, the humidity source was injected through the living room's supply air to avoid the necessity to enter the houses during the experiment to refill the evaporators as shown in Figure 29. Figure 30 gives an overview of the estimated building's total moisture gains during the entire test period. A comparison between the heat and moisture profile can be found in Figure 31. The fresh air temperature "o5\_ZVent\_out\_Tamb" was not part of the data provided for the Main Experiment and was added for the Extended Experiment at the end of the O5 data files to preserve the original file structure.

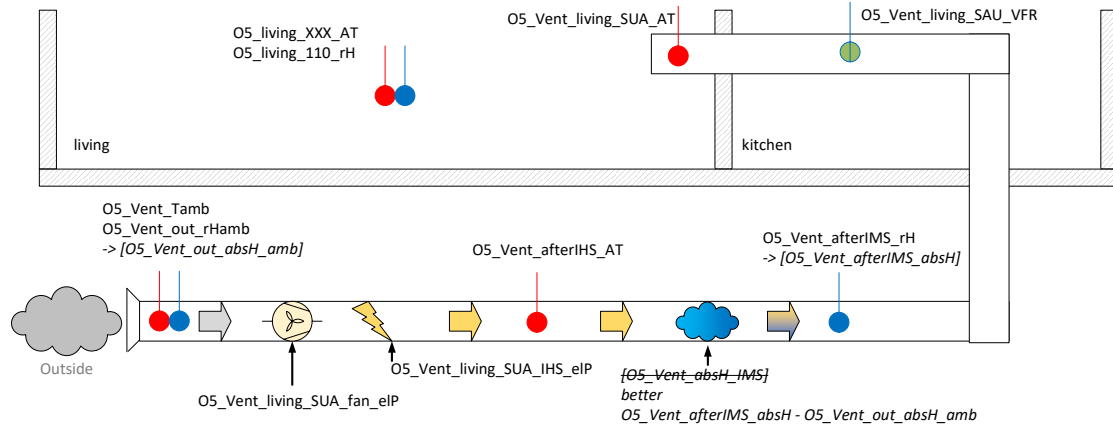

Figure 29: Realisation of the internal moisture source through the living room's supply air system.

This internal humidity source profile is calculated according to Equation (1), following the course of the internal heat source profile. The average daily internal humidity source is chosen to be about 8 kg/day, representing a 4 person family household [15]. The minimum value is set to 0.2 kg/h and the maximum to 1.3 kg/h.

$$\dot{w}_{IMS} = \dot{w}_{IMS,min} + \frac{\dot{Q}_{IHS}}{\dot{Q}_{IHS,max}} (\dot{w}_{IMS,max} - \dot{w}_{IMS,min}) \quad (1)$$

$\dot{w}_{IMS}$	water vapour mass injection rate of the internal moisture source	[kg/h]
$\dot{w}_{IMS,min}$	minimum water vapour mass injection rate of the internal moisture source	[kg/h]
$\dot{w}_{IMS,max}$	maximum water vapour mass injection rate of the internal moisture source	[kg/h]
$\dot{Q}_{IHS}$	power of the internal heat source	[W]
$\dot{Q}_{IHS,max}$	maximum power of the internal heat source	[W]



The provided absolute humidities are calculated from the corresponding relative humidity and air temperature according to Equation (2). To calculate the water vapour saturation pressure the Magnus formula [16] was used.

$$H_{abs} = \frac{610.78 * e^{\frac{17.08085 * \theta_{air}}{234.175 + \theta_{air}}} * \frac{H_r}{100\%}}{\frac{R_w * (273.1 + \theta_{air})}{\rho_{air}} * 1000} \text{ g/kg} \quad (2)$$

$H_{abs}$	absolute air humidity	[g/kg]
$\Theta_{air}$	air temperature	[°C]
$H_r$	air relative humidity	[%]
$R_w$	gas constant of air: 462 J/(kg*K)	[J/(kg*K)]
$\rho_{air}$	density of air (set to 1.2041 kg/m <sup>3</sup> )	[kg/m <sup>3</sup> ]

Due to the injected humidity source by the supply air, design set points for temperature and relative humidity of the ventilation device are necessary. They are calculated considering the estimated climate data for the location. Outdoor air must be heated to transport the humidity. This supply air set point temperature is kept between 5 and 17 °C. According to the internal humidity source profile, the absolute humidity of the estimated outdoor air condition and the supply air volume flow rate, the relative humidity supply air set point is calculated. However, the relative humidity is constrained between 30 and 90 %.

Due to the usage of estimated climate data in the figure, the provided internal humidity source during the test may differ compared to the shown profiles.

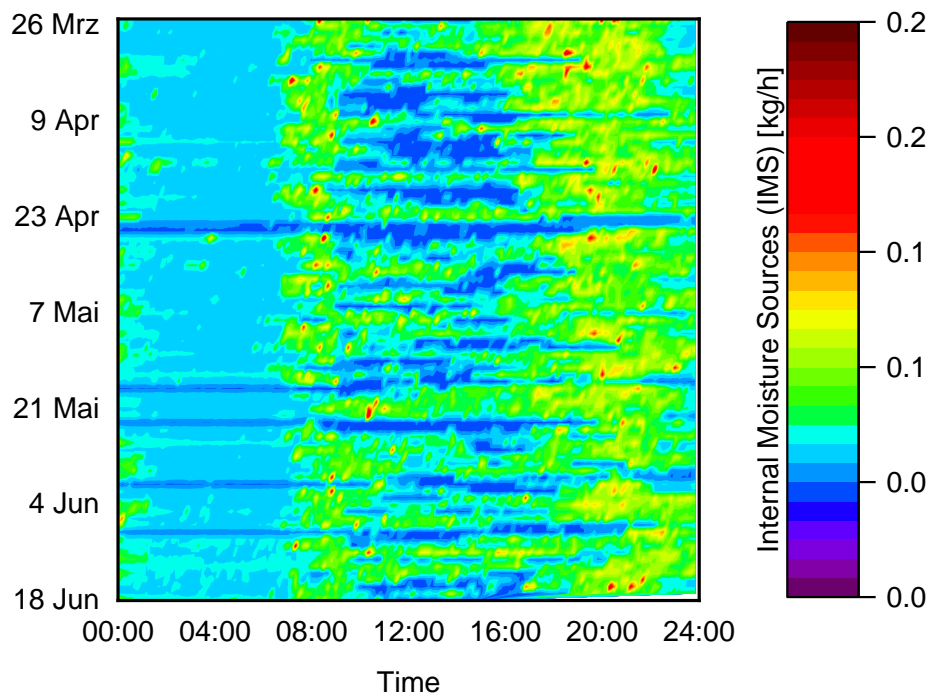

Figure 30: Internal moisture gains for the entire building for the complete period.



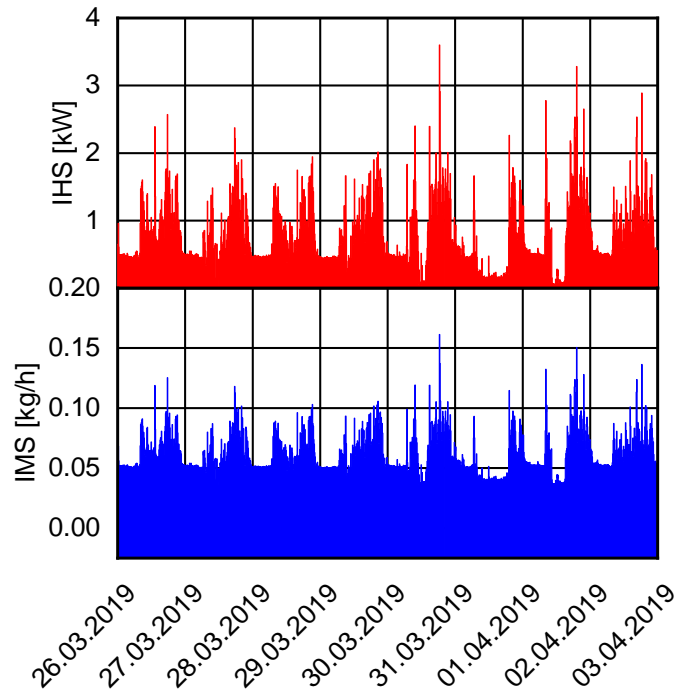

Figure 31: Comparison between the internal heat and moisture load profiles over a period of eight days.

#### 3.15.4 Internal CO<sub>2</sub> sources

This is not possible since CO<sub>2</sub> is one of the tracer gases used to monitor intra-room air exchange.

#### 3.15.5 Set temperatures

A set temperature of 21 °C was chosen for occupied rooms, with 17 °C as the (night-time) setback temperature. All set temperatures / profiles are realized through room thermostats and not by the heat source / heat pump (e.g. setback of the supply temperature) to avoid complicated interactions in the hydronic system. Figure 32 shows two example days of this dataset. These occupancy data are provided as a time series dataset. It is assumed that the heating system will not be put on setback for an absence period of 2 hours or shorter.

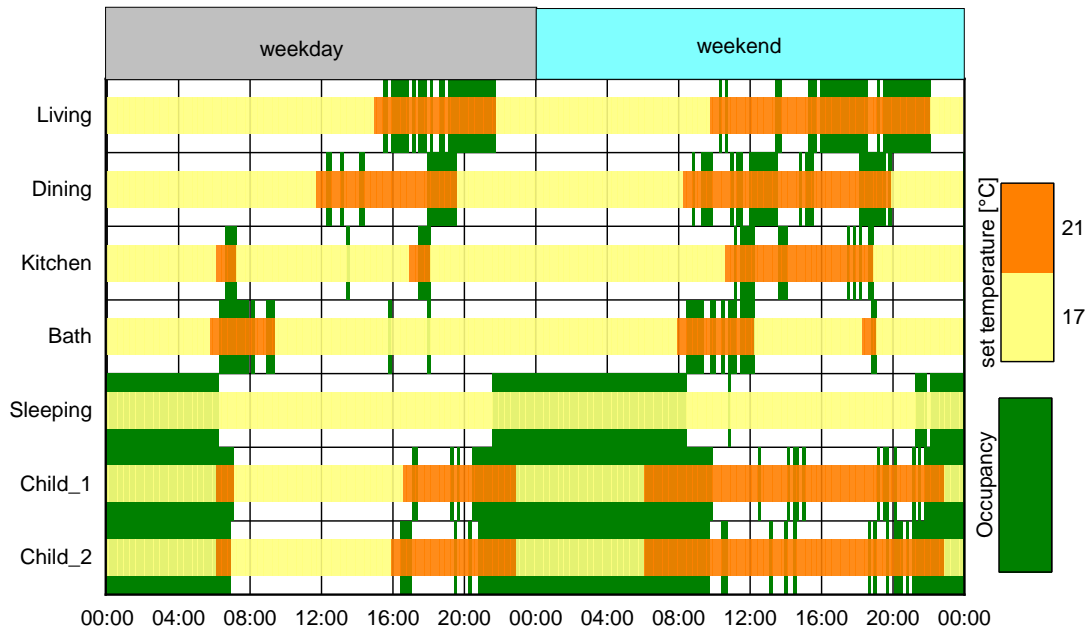

Figure 32: Resulting occupancy and set temperatures for two example days.

### 3.15.6 External window and internal doors

The operable external window is located in the child1 room. The operable internal door is located between the living room and the kitchen. The four possible configurations of both operable components defined in Table 16 were cycled through the injections. Since the injection cycle is 12 hours, the total cycle of the four possible configurations was 48 hours.

Table 16: Operation cycle of the operable external window and internal door.

No.	external window	internal door
1	closed	closed
2	closed	open
3	open	closed
4	open	open

The intra-room airflow was monitored with a two-gas tracer gas system during the Extended Experiment. The tracer gas setup is described in section 5.3. The gas monitor (Innova PD 1412 PW) is specified with a detection dynamic of the factor 100000 for the gases used in the experiment. The following ranges are applicable:

- SF<sub>6</sub>: 0.006 – 600 ppm (filter: 988)
- CO<sub>2</sub>: 0.06 – 6000 ppm (filter: 973)

The living room has a volume of 87 m<sup>3</sup> and a mechanical ventilation rate of 100 m<sup>3</sup>/h (1.14 h<sup>-1</sup>). To decay to 110 % of the atmospheric CO<sub>2</sub> concentration (700 ppm; see Figure 33) takes 5 hours.

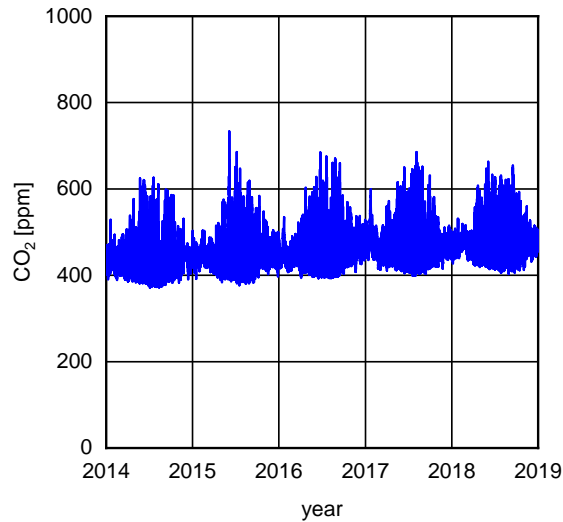

Figure 33: CO<sub>2</sub> cycle over the years 2014 – 2019 in Holzkirchen; 1 hour sampling.

### 3.15.7 Roller blinds

The roller blinds and their influence on solar gains and transmission losses were investigated in Annex 58. Therefore it was decided not to operate them in this experiment. The blinds on the north, east and south facade are open permanently while the blinds of the west facing windows of the ground floor are always closed. The reason for this is a slightly different external shading of solar radiation on the two houses in winter because of a new test facility on the site. The attics' west façade roller blind of the child 1 room remains open so the airflow through the operable window is not obstructed.

### 3.15.8 Domestic Hot Water

The domestic hot water demand during the user 1 phase is calculated by the occupancy model (see Figure 34) and provided as a time series along with the other measurement data.

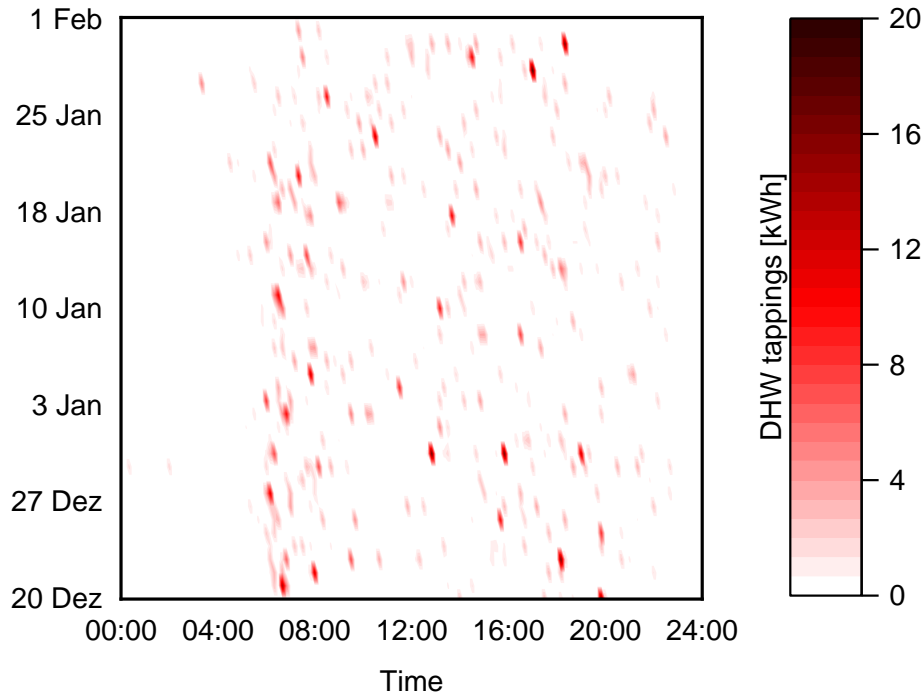

Figure 34: Domestic hot water tapplings during the user-1 phase.

### 3.16. Weather

The weather data during the experiment is collected on site and provided to the modelling teams. Site wind speed is measured at the standard 10 m above the ground. The weather data is collected at 1 minute intervals and is provided as 10 minute and hourly averages.

### 3.17. Ground properties

Shortwave ground reflectivity was measured previously over grass as 0.23 (measurement data of about 2 days). Additional measurements of ground reflectivity have been made above asphalt (0.17) and gravel (0.45). During the experiment the albedo in front of the south windows of both houses was measured continuously.

Measured ground temperatures are included at a number of depths (0 m, 0.05 m, 0.1 m and 0.2 m). The sensor at 0 m is not exposed and is now covered by soil and grass.

#### 4. Experimental schedule

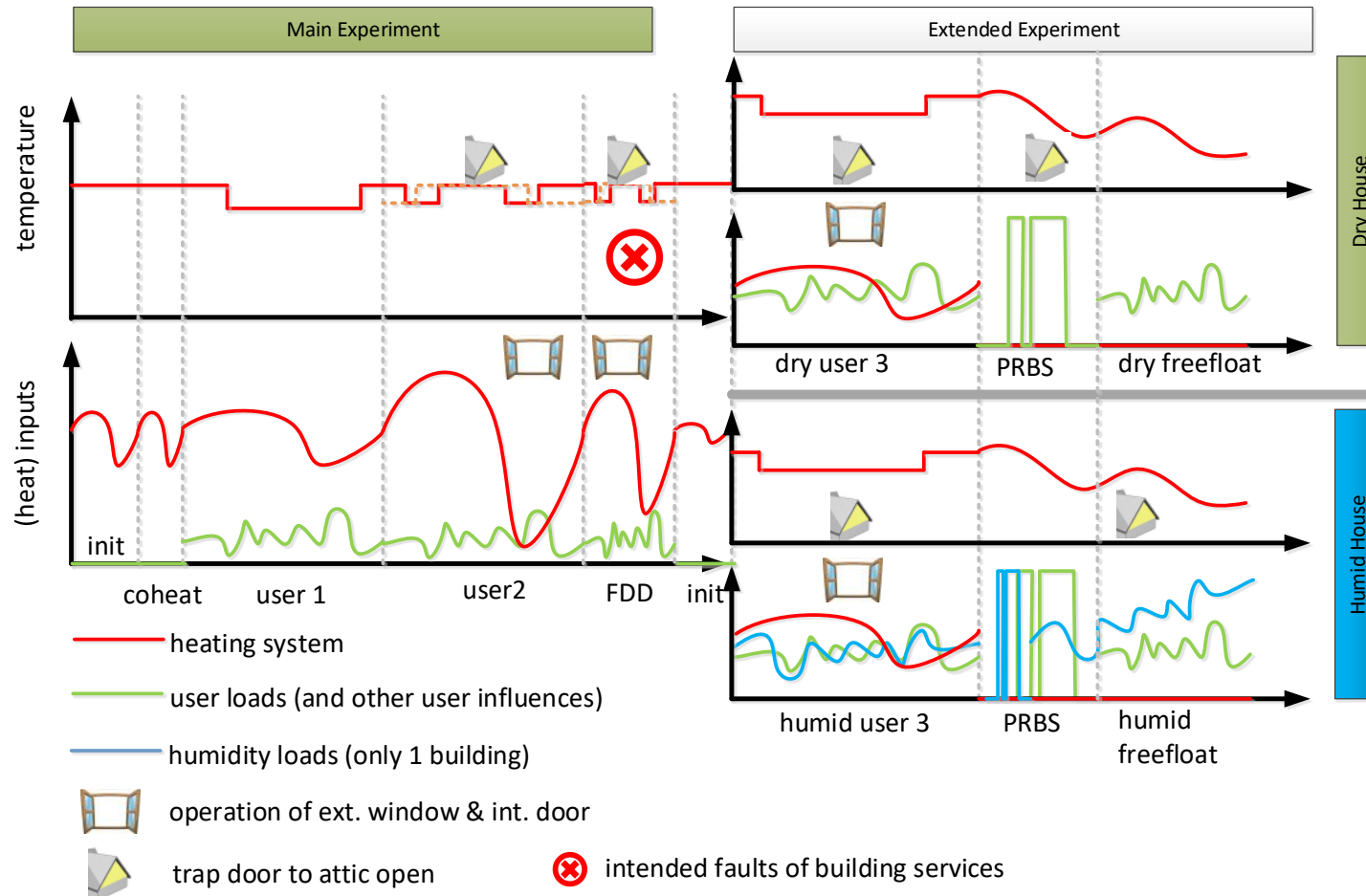

Figure 35: Experimental schedule

Table 17: Experimental configuration of all phases.

	coheating	user1	user2	FDD	reinit	user3 (moisture)	free PRBS	free float	tracer gas
Duration [days]	7 start: 7.12.2018 18:00	35	30	14	7	25	~8/8/8/8	20	1.5
End	19 <sup>th</sup> Dec. 9:00	1 <sup>st</sup> Feb. 10:30	1 <sup>st</sup> March 00:00	16 <sup>th</sup> March 13:30	22 <sup>nd</sup> March 10:30	25 <sup>th</sup> April 10:30	26 <sup>th</sup> May 22:20	18 <sup>th</sup> June 7:00	19 <sup>th</sup> June 17:00
set temperature	constant	Night setback; identical for all rooms	room wise profile, incl. stochastic deviations	room wise profile, incl. stochastic deviations	constant	room wise profile, incl. stochastic deviations	5°C	5°C	5°C
heating power	variable	variable	variable	variable	variable	variable	0	0	0
heating system N2	electrical	electrical	electrical	electrical	electrical	electrical	-	-	-
heating system O5	electrical	UFH	UFH	floor	electrical	electrical	-	-	-
thermal user profile		incl. stochastic deviations	incl. stochastic deviations	incl. stochastic deviations	-	incl. stochastic deviations	PRBS	incl. stochastic deviations	-
moisture user profile	-	-	-	-	-	O5 only; incl. stochastic deviations	O5 only; 2 large pulses then	O5 only; incl. stochastic deviations	-

							stochastic deviations		
internal doors kitchen living	open	open	operated (Closed: 00:00 - 6:00 Open: 6:00 - 24:00)	<i>operated</i> (Closed: 00:00 - 6:00 Open: 6:00 - 24:00)	open	operated (Closed: 00:00 - 6:00 Open: 6:00 - 24:00)	open	operated (O5) (Closed: 00:00 - 6:00 Open: 6:00 - 24:00)	<i>open</i>
doors sleeping	open	open	closed	<i>closed</i>	closed	closed	closed	closed	<i>closed</i>
roller blinds	living closed west	living west closed	living west and kitchen closed	<i>no change</i>	no change	no change	no change	no change	<i>no change</i>
operable window (Child1)	closed	closed	operated (24 h cycle)	<i>operated</i> (24 h cycle)	closed	operated (24 h cycle)	closed	closed	<i>closed</i>
mechanical ventilation	off - sealed	on	on	<i>on</i>	on	on	on	on	<i>off - sealed</i>
trap door to attic	open	closed	open	<i>open</i>	open	open	open/open	open	<i>open</i>

O5 is the house with underfloor heating during the main experiment and the “wet” house during the extended experiment.

#### **4.1. Initialisation phase(s)**

These periods were used to bring both buildings to identical initial conditions for the experiment. All rooms of both buildings were set to the same constant set temperature. The ventilation system was on and no occupancy profile was implemented.

In the first initialisation phase all doors were open since this was required for the coheating test. Also both buildings were heated electrically as this is also required for the coheating test.

In the 2<sup>nd</sup> re-initialisation phase, all doors were open or closed according to the chosen setup (see section 3.3, Figure 6 and Figure 7).

#### **4.2. Coheating phase**

The coheating phase has two purposes. On the one hand the Heat Loss Coefficients of both buildings are determined to be available as a baseline for all further analysis. On the other hand it serves as a simple constant temperature phase to give the modelling teams a possibility to have and check a model with basic functionalities only. To be comparable both buildings are heated using electrical heaters. The ventilation system is off and no occupancy profile is included. This coheating experiment is carried out in compliance with the draft of "CEN/TC89/WG13 TG5 (Working Draft 12/01/17)". In this phase every room is equipped with a fan to break the air temperature stratification. The electrical input of the supply fans is included in the measured data as separate channels, as is the exhaust fans' consumption. The supply air temperatures are measured after the fans, the exhaust air temperature before them. The fans are switched off in other experimental phases (e.g. user-1 and user-2 phases). The constant set temperature for the coheating phase is 21 °C.

#### **4.3. User-1 phase**

In this phase the occupants' influence was created through synthetic user profiles while the building was heated using electrical (N2 house) or hydronic underfloor heating (O5 house). The user-1 phase is a simple realistic phase with mechanical ventilation and identical temperatures in all rooms including a night setback between 23:00 until 6:00. The purpose of this phase is to check if simulation programs are able to reproduce more complex cases than the coheating phase or the Annex 58 experiment and can handle user interactions such as small room-wise occupancy differences and some building service equipment (underfloor heating).

#### **4.4. User-2 phase**

In this phase the occupants' influence is created through synthetic users while the building is heated using electrical/hydronic underfloor heating. The user-2 phase is a more complex realistic situation including operating internal doors and external windows and different set temperature profiles in the individual rooms.

The purpose of this phase is to check if simulation programs are able to reproduce more complex cases than the coheating phase or the annex 58 experiment and can



handle user interactions like changing air flows caused by operated windows and doors, more significant room-wise occupancy differences and basic building service equipment (underfloor heating and ventilation).

#### **4.5. FDD phase**

This part of the experiment was specified by Annex 71 Subtask 2 and is not part of the validation experiment. This phase is identical to the phase user 2 but two errors in the building service systems were introduced deliberately to provide data to test fault detection abilities of various algorithms.

#### **4.6. User-3 phase: including moisture release**

The purpose of this phase was to check if simulation programs are handling the thermal and energetic influences of moisture effects and how significant the influence of the moisture is in general. It is similar to the user-1 phase but with additional moisture source in house O5. To ensure that both Twin Houses are identical except for the presence of the moisture source in this phase both houses were heated electrically. The heat pump provided DHW only. The trap door to the attic space was opened for this experiment.

#### **4.7. Free PRBS-phase**

In this phase there was no heating and instead of the synthetic users a Pseudo Random Binary Sequence (PRBS) with heat pulses of 700 W was realized through the electric convectors. In this sequence the ground floor and the attic were partially excited synchronously, partially separately and with two different frequencies in both setups, synchronously and partially. This phase was located at the end of the experimental schedule because as a free-float experiment it is not negatively impacted by higher external temperatures that could occur during the start of the spring season. The purpose of this free PRBS phase was to create a dataset that is optimized for statistical identification tasks and could be realized in this design in a real building.

#### **4.8. Free-float phase**

There was no heating in this phase, but synthetic users were included. This phase is located at the end of the experimental schedule because as a free-float experiment it is not negatively impacted by higher external temperatures that could occur during the start of the spring season. The purpose of this free-float phase was to test if simulation programs are able to correctly predict performance with heat inputs dominated by solar gains under summer conditions. The purpose of the free-float in the wet building (O5) was to check if simulation programs can include the thermal and energetic influences of moisture effects and how significant the influence of the moisture is in general.

#### 4.9. Tracer gas air change rate measurement (O5 house only)

For the last 1.5 days of the experiment the O5 houses infiltration was measured by tracer gas. The mechanical ventilation was inactive and the inlets and outlets were sealed on the outside.

### 5. Instrumentation

#### 5.1. Overview

A detailed overview of all existing measurement channels, used instrumentation and data loggers, calibration certificates and associated accuracies can be found in the "Measurement Channel List.xlsx" among the additional documents provided. All instrumentation values are recorded with a frequency of 1 second and are stored as 1 minute means. The calculation of all hydronic and ventilation thermal powers is also performed at 1 second intervals and stored as 1 minute mean values.

- external climate (full weather station):
  - air temperature
  - ground temperatures
  - sky temperature
  - solar radiation (global, diffuse, (direct is calculated), total vertical in all 4 main orientations)
  - wind speed and direction
  - 2x South Albedo (downward-facing sensor )
  - CO<sub>2</sub>
- electric power consumption
  - heaters, room wise
  - internal heat sources, room-wise
  - heat pump (compressor, controls, direct heating)
  - supply and extract fans
  - heat pump auxiliary heater (UFH)
  - DHW storage auxiliary heater
- heat pump
  - supply and return temperatures
  - flow rates
  - (thermal power is calculated; 1 second basis)
- domestic hot water
  - hot water flowrate and temperature
  - cold water supply temperature
  - buffer vessel temperatures (1 or 3 positions)
- under floor heating (room wise)
  - supply temperature
  - return temperature
  - flow rate
  - thermal power is calculated
  - 2x Heat flux sensors under child-1 and living room
- ventilation (central and point-wise)
  - supply / exhaust air temperature

- supply air humidity (O5, wet house)
- air flow
- rooms (all)
  - air temperature @4 heights  
10 cm, 110 cm, 170 cm and 10 cm below ceiling
  - globe temperatures @ 110 cm
  - relative humidity
- air flows through tracer gas measurement; for all air bodies (only in 1 house)  
started at: March 11<sup>th</sup> 2019
- cellar air temperature (2x); 30 cm below ceiling;  
located at the columns closest and furthest from cellar door
- constructions:
  - 2x heat flow through west wall: location internal surface centre of wall
  - 2x internal west wall temperature between plastered brick and thermal insulation composite system
  - 2x internal and external surface temperature west wall
- internal solar irradiance behind the living room's south window (O5 house)
- draught through open doors
  - investigated at the door between living and corridor
  - air speed sensors inside the doorframe @~ 3 heights  
10 cm, 110 cm, 170 cm.  
1 measurement per minute; not 1 minute means.

## 5.2. Coheating concept

The coheating test was conducted with electrical heating only and fans were used to break the air stratification and to reach homogenous air temperatures. The required devices' locations are shown in Figure 36. Only in this phase every room was equipped with a fan to break the air temperatures' stratification.

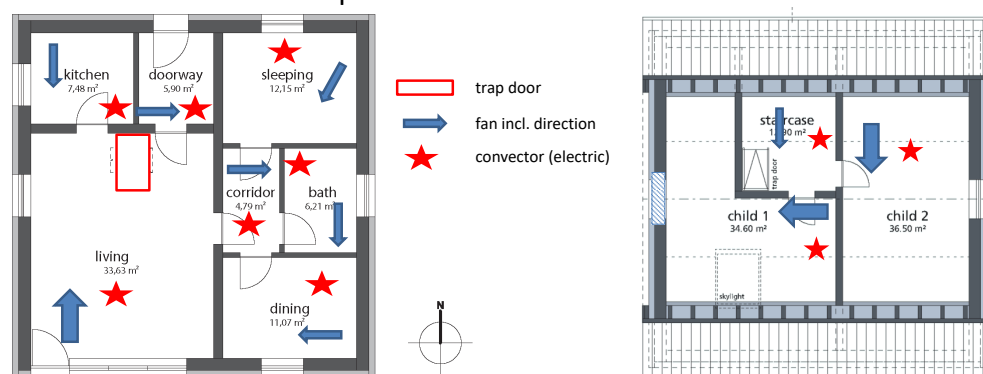

Figure 36: Setup of electrical heaters and fans during the coheating test in the ground floor and the attic

### 5.3. Tracer gas concept

The tracer gas measurement accompanying the Extended Experiment started on March 11<sup>th</sup> 2019. Tracer gases SF<sub>6</sub> and CO<sub>2</sub> were used. SF<sub>6</sub> is not part of the natural atmosphere and therefore doesn't require compensation concerning the outside and supply air. CO<sub>2</sub> however is part of the exterior air. The current CO<sub>2</sub> concentration is available from the weather data of the IBP's weather station. The tracer gas measurement is only available in the O5 house (underfloor heating). For all used gases 6 (identical) sampling points are available. One sampling point was installed into the supply air to give an accurate measurement of the outside gas concentration. For the CO<sub>2</sub>-injections a boolean signal ("O5\_CO2\_dosing\_flow") is available; for the SF<sub>6</sub> this is not the case. This described setup can be found in Figure 37. SF<sub>6</sub> is injected into the living room and CO<sub>2</sub> into the child 1 room. These data can be found in "04\_Data\_Extended\_Experiment.zip\TracerGas".

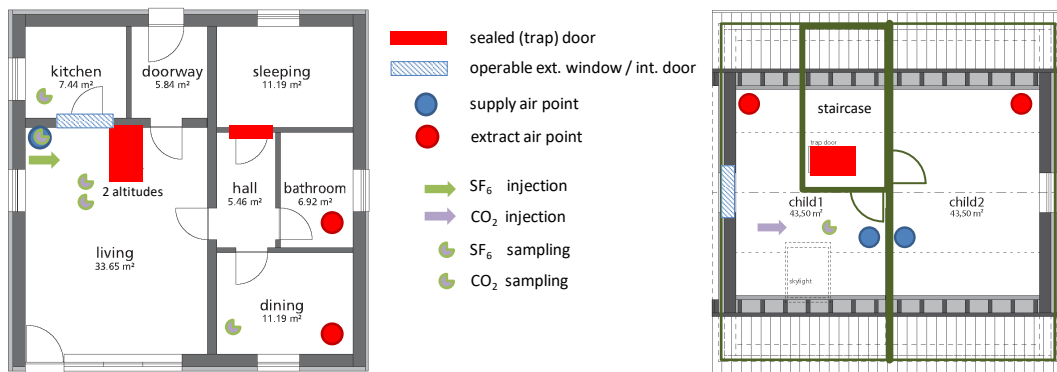

Figure 37: Illustration of the tracer gas concept on the ground floor (left) and the attic space (right)

## 6. Practical aspects of modelling the measured data

### 6.1. Overview

A key element of this validation study is that the focus is on testing the capability of simulation programs to predict performance, given knowledge of boundary conditions and internal heat gains. It is not aimed at testing the ability of users to construct a model (although the dataset can also be used for this training purpose). Therefore, modelling teams are encouraged to undertake quality assurance of their models, perhaps by another experienced modeller, in order to reduce the likelihood of input errors.

The remainder of this section sets out the modelling instructions for participating modelling teams in the Annex 71 validation experiment. Modellers using the experimental datasets subsequently can follow the same procedure, or adapt it to their own requirements.

#### Coheating / Constant temperature period

- Both houses have electric heating controlled to a nominal constant setpoint (21 °C). There are no internal gains apart from the fans and no mechanical ventilation.
- Measured air temperatures are provided (there are occasions of overheating due to solar radiation, so measured temperatures as well as the setpoint temperature are provided). The temperatures provided are the air temperatures at mid-height in the room (110 cm). The measured fan power is also provided as an integral for the entire buildings' electrical sockets.
- Modellers are asked to predict heat input to electric heaters. Modellers only need to model one house, as the constructions and operations are identical (both have underfloor heating installed, but not operational in this period). However, due to sensor uncertainty, the measured temperatures differ slightly, so modellers should provide results for both houses. The O5 houses corridor has constant heat gains of 12x 2.4 W due to the installed flow meters.
- **Initialisation period.** The first three days of the coheating experiment can be included in the results but will be excluded in the analysis to compensate for initialisation effects. Internal preconditioning of the building to a constant 21 °C can be assumed.

#### User-1 and User-2 periods

##### **House O5: Underfloor heating (UFH)**

- The house is much more dynamic in these periods - internal heat gains, plus window/door openings in the user-2 period.  
User-1 period: setpoint 21 °C with 17 °C night setback for all rooms between 23:00 and 6:00.  
User-2 period: setpoints (21/17 °C) vary between rooms.
- Measured internal heat gains are provided.

- Inputs provided are supply flow rates and temperatures to each UFH circuit. After the blind validation phase, the total thermal input to the UFH will be provided. This is based on 1 second data to avoid averaging errors.
- Setpoint temperatures (for the air temperature in centre of rooms at 110 cm height) are provided but they may not be achieved at all times.
- Modellers should predict the room air temperature for comparison with the measured/calculated volume-averaged air temperature in the rooms and for comparison with the measured air temperature at the centre of the room. (In practice, most modellers are likely to be assuming fully mixed spaces.) Additional information on stratification should be provided by modellers, if possible. The open phase measurement data provide information on the stratification at four heights.
- Modellers should use the provided room-wise supply temperatures and flowrate instead of the setpoint signal.
- Modellers should also predict the UFH's return temperatures.
- For teams wishing to model the heat pump, data is provided on the compressor's power consumption and switching information on the direction of heat flow for the defrosting cycle and on/off switching of the direct electric auxiliary heater. Note that during the user-1 period the heat pump is also producing domestic hot water on a priority option, meaning the heating's supply will stop during DHW production.

#### **House N2: (reference) electric**

- The schedule in the user-1 and user-2 periods (temperature setpoints, internal heat gains, door and window operation) are the same as for house O5.
- Measured heat inputs into each room are provided, separated into the scheduled (measured) internal heat gains and additional heat inputs that are trying to maintain the setpoint.
- Heating setpoints are provided, but they may not be achieved at all times, and may also be exceeded in periods of high solar radiation. Air temperature in centre of rooms (@110 cm).
- The measured heater capacity (nominally 2 kW) ranges from 1.80 to 1.93 kW. However, this will not affect the modelling predictions because measured heat inputs are provided.
- As mentioned above, internal heat gains and additional heater inputs are provided as separate inputs. For the kitchen and the bathroom, the internal heat gains and additional heater inputs are measured separately. For the living room, bedroom, child 1 room and child 2 room, which only have 1 heater, this is a calculated split based on the internal heat gain scheduled values. The dining room has heating only (no internal heat gains); the corridor has only internal heat gains; doorway and stairs have no heat input after the coheating phase.
- Modellers should predict the room air temperature for comparison with the measured/calculated volume-averaged air temperature in the rooms and for comparison with the measured air temperature at the centre of the room. (In practice, most modellers are likely to be assuming fully mixed spaces.) Additional information on stratification should be provided by modellers, if

possible. The open phase measurement data provide information on the stratification at four heights.

- Modellers should use the provided room-wise heat inputs instead of the setpoint signal.

### **Both houses**

- The measured exhaust temperatures from the mechanical ventilation system are not available in the blind validation phase, but will be available thereafter in the open phase.
- The supply air fan power is provided in case modellers wish to model the ductwork. The ductwork is insulated, but there will still be residual losses. The supply air temperatures are measured after the supply fans' heat input. The exhaust fans are located after the exhaust air temperature sensors.

Modellers are also encouraged to provide more detailed data – e.g. temperature distribution in rooms where this has been predicted, and air change rates through internal doors and the operable external window.

Modellers are encouraged to undertake sensitivity studies and include results of these in the modelling report. For those teams undertaking sensitivity analyses, it is suggested that the following parameters could be investigated:

- radiative-convective split of the heating system
- uncertainty in the temperatures in the cellars of the two houses
- infiltration assumptions
- assumptions concerning the operable external window
- uncertainty in the measurement of the internal heat gains
- interaction between stratification and exhaust air temperature

## **6.2. Main Experiment: operational details**

Figure 38 shows a series of central measurement data of both Twin Houses. Some gaps of short measurement failures were filled by linear interpolation for temperatures and set to zero for powers and flowrates.

In the top left, the measured air temperatures in all rooms at a height of 110 cm are shown.

In the middle left the buildings' set temperatures of all heated rooms are shown. In first quarter of the dataset (24.12.2018 07:00 until 25.12.2018 11:00) the set temperatures of the O5 building drop to "0" in the provided data. Here the O5 building's PLC did not properly reboot after a power failure of a few seconds. This also affects the IHS (top right) the ventilation (middle right) and the underfloor heating. The O5 building is in free float during this period.

Thorough investigations showed that the O5 building went to electrical heating with a constant setpoint of 21 °C. The heating power was simulated, and the missing data filled for all ten “heat\_eIP” columns in this period.

The set temperatures (middle left also) also show a quite regular behaviour in the first half of the non-coheating measurements during the user-1 phase and a more complicated behaviour later in the main experiment during the user-2 phase. Also, during the user-1 phase about 1.5 days (hour ~6500) a more complicated behaviour can be seen. Here the user-2 profile was started too early and was reset to user-1 as soon as the deviation was discovered. This affects the set temperatures, the resulting heating inputs and the IHS.

The O5 house shows some electrical heating power at the beginning of the user-1 phase (bottom left). These heat inputs occurred in reality due to an improper configuration of the PLC.

The IHS (top right) and the ventilation flow rate (middle right) show some very short peaks during the coheating phase. These occurred because of short (unsuccessful) changes to the O5’s PLC. The same is true for the single peak in the N2’s supply air temperature (bottom right).

In some extreme winter conditions (e.g. morning of 1<sup>st</sup> of January) the external ventilation inlets can be cloaked by ice and cause reductions from the set values until they have been de-iced. However, the measured flow rates are given as input data so this information can be included in the model.

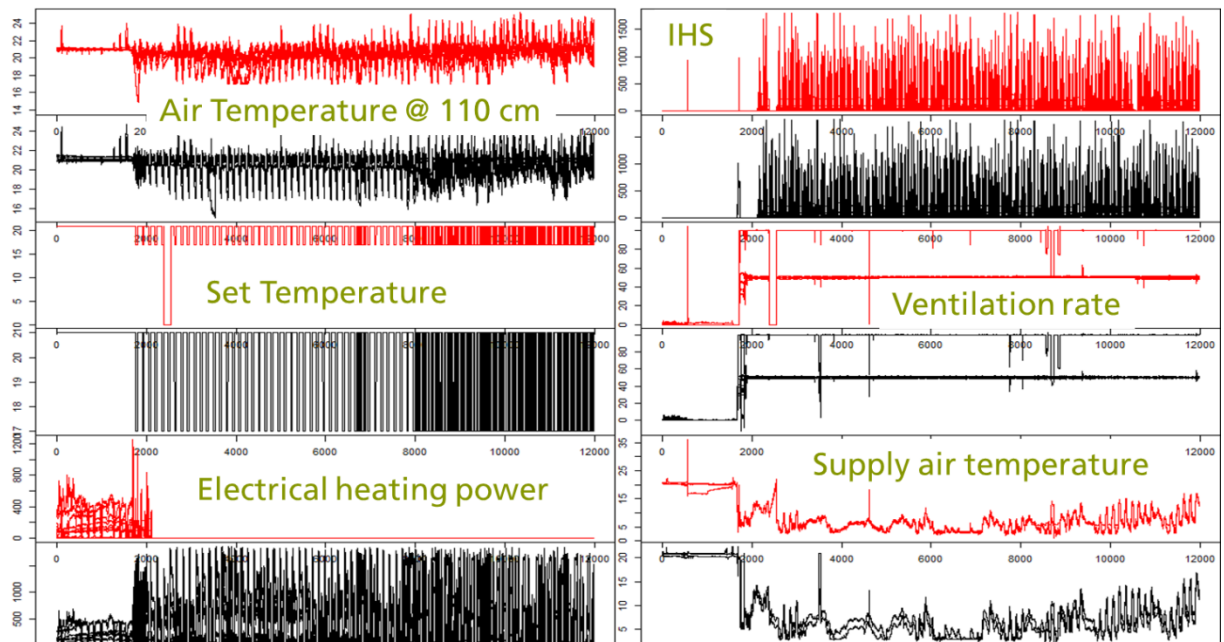



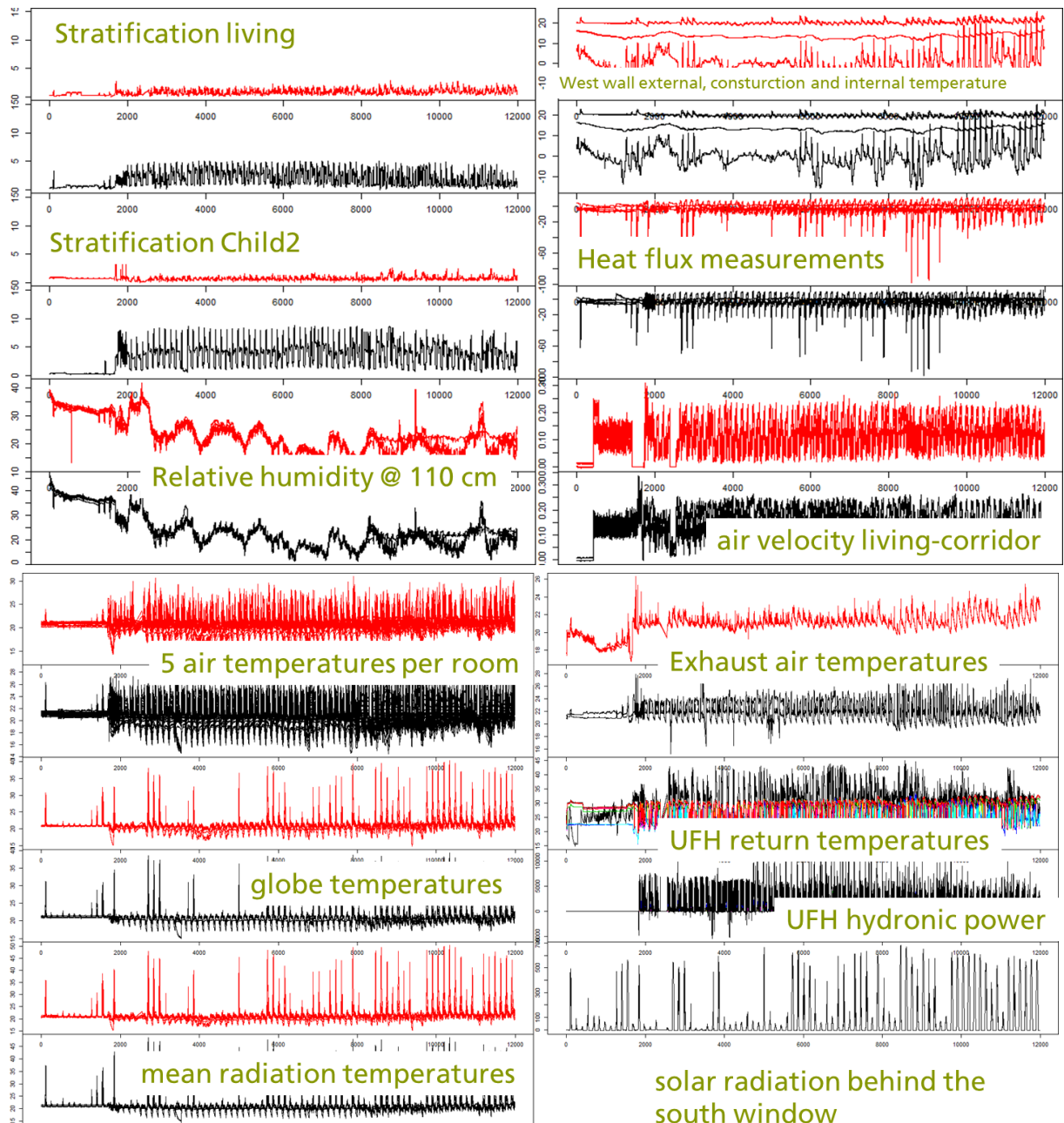

Figure 38: Selection of the Main Experiment's measurement data of the O5 house (red) and the N2 house (black).

### 6.3. Extended Experiment: operational details

Figure 39 gives an overview of the data provided for the Extended Experiment. The dining room's PRBS power signal was measured on the heating power channel since the dining room has no separate IHS channel. This is the reason the PRBS can be seen at the heating and the IHS.

In the N2 house, a decrease in the living room's supply air ventilation rate (nominally  $100 \text{ m}^3/\text{h}$ ) can be seen towards the experiment's end. To provide an uninterrupted

dataset the experiment was not stopped to fix the fan. This drop is contained in the measurement data and should be considered in the simulation model.

For the Extended Experiment the measured concentrations of the two tracer gases are provided in the "CONCENTRATION\_10/60Min.xlsx" files.

After the user-3 phase the air velocity sensors between living and corridor of the N2 house were needed in another experiment.

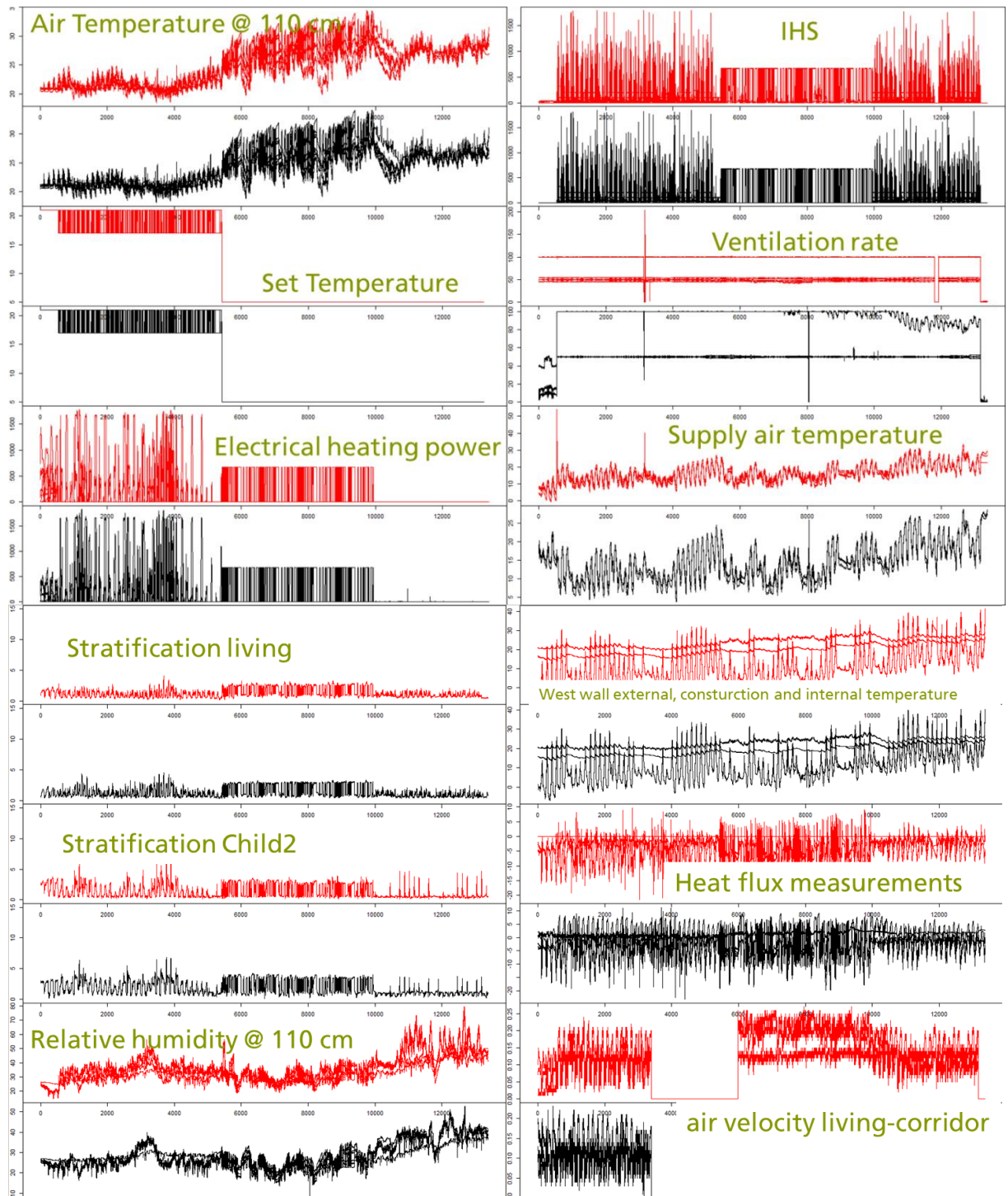

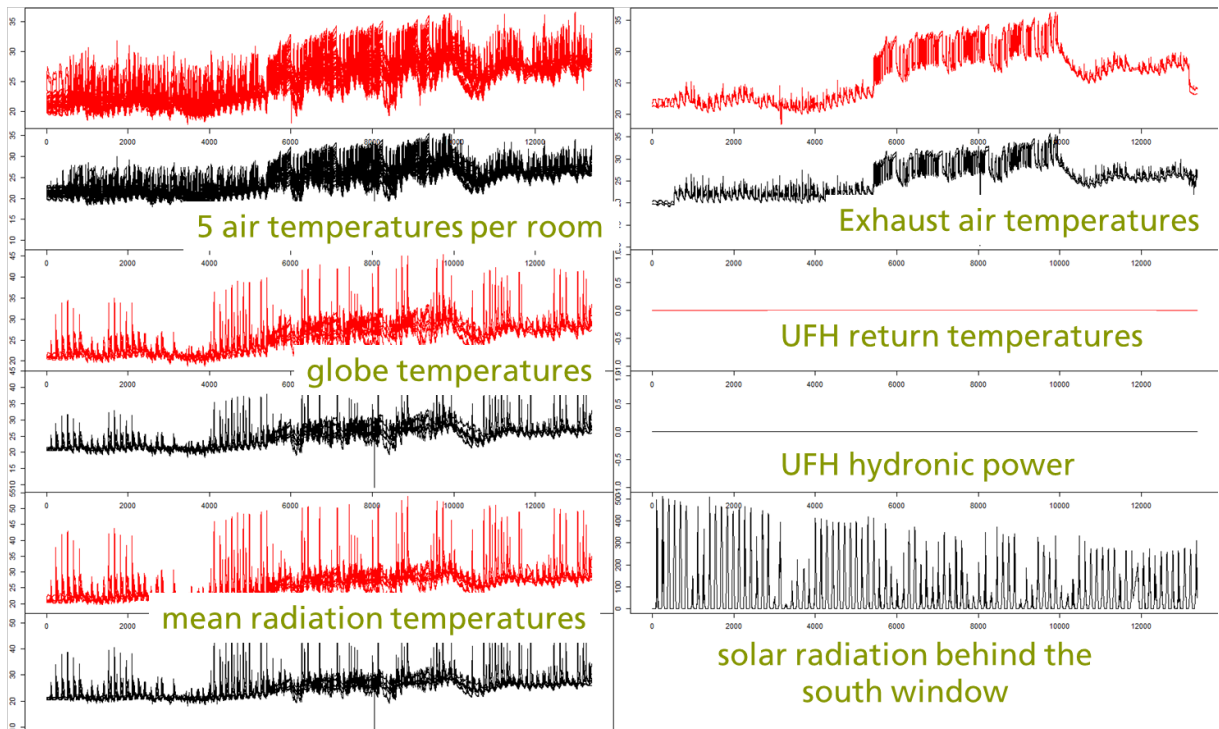

Figure 39: Selection of the Extended Experiment's measurement data of the O5 house (red) and the N2 house (black).

## 7. Acknowledgements

The contributions of the Fraunhofer Institute for Building Physics IBP were funded by the German Federal Ministry of Energy and Economic Affairs BMWi under the registration number O3ET1509A.

The sensitivity analysis for the experimental design (section 2) was undertaken by Eirini Mantesi and Kostas Mourkos from the School of Architecture, Building & Civil Engineering, Loughborough University.

The thermal bridge analyses were undertaken by Jørgen Rose from the Danish Building Research Institute, SBi, Aalborg University using HEAT2, and Felix Thomas from the Leeds Sustainability Institute, School of Built Environment and Engineering, Leeds Beckett University using TRISCO.

To aid the design of the Tracer Gas Experiment a Contam simulation was conducted by Gabriel Rojas-Kopeinig from the University of Innsbruck.

The stochastic user profiles for the experiment and the sensitivity analysis were provided by Graeme Flett of the Energy Systems Research Unit, University of Strathclyde, Glasgow, G1 1XJ, UK.

## 8. References

- [1] M. Kersken and P. Strachan, *IEA EBC Annex 71 - BES model Validation Data* - <http://dx.doi.org/10.24406/fordatis/75>.
- [2] KU Leuven, 17 04 2015. [Online]. Available: <http://www.kuleuven.be/bwf/projects/annex58>.
- [3] P. Strachan, K. Svehla, M. Kersken and I. Heusler, "Reliable building energy performance characterisation based on full scale dynamic measurements - Report of Subtask 4a: Empirical validation of common building energy simulation models based on in situ dynamic data," Leuven (Belgien), 2016.
- [4] "Annex 58 - BES-Model Validation DATA: doi: 10.15129/8a86bbbb-7be8-4a87-be76-0372985ea228," [Online]. Available: <https://pure.strath.ac.uk/portal/en/datasets/twin-houses-empirical-dataset-experiment-1%288a86bbbb-7be8-4a87-be76-0372985ea228%29.html>.
- [5] "Annex 58 - BES-Model Validation DATAsE t 2: doi: 10.15129/94559779-e781-4318-8842-80a2b1201668," [Online]. Available: [https://pure.strath.ac.uk/portal/en/datasets/twin-houses-empirical-validation-dataset-experiment-2\(94559779-e781-4318-8842-80a2b1201668\).html](https://pure.strath.ac.uk/portal/en/datasets/twin-houses-empirical-validation-dataset-experiment-2(94559779-e781-4318-8842-80a2b1201668).html).
- [6] P. Strachan, K. Svehla, I. Heusler and M. Kersken, "Whole model empirical validation on a full-scale building," *Journal of Building Performance Simulation*, vol. 9, no. 4, pp. 331-350, 09 2015.
- [7] F. Schlachter, J. Scofield and J. Dawson, "ENERGY FUTURE: Think Efficiency - How America can look within to achieve energy security and reduce global warming," <http://www.aps.org/energyefficiencyreport/>, 2008.
- [8] G. Flett and N. Kelly, "An occupant-differentiated, higher-order Markov Chain method for prediction of domestic occupancy," *Energy and Buildings*, no. 230, pp. 219-230, 2016.
- [9] G. Flett and N. Kelly, "A disaggregated, probabilistic, high resolution method for assessment of domestic occupancy and electrical demand," *Energy and Buildings*, no. 140, pp. 171-187, 2017.
- [10] E. Mantesi, K. Mourkos, C. Hopfe, R. McLeod, P. Vatougiou, M. Kersken and P. Strachan, "Deploying Building Simulation to Enhance the Experimental Design of a Full-scale Empirical Validation Project," in *Proceedings BuildingSimulation2019*, Rome, Italy, 2019.
- [11] *DIN V 18599 (E):06-2016: Energy efficiency of buildings — Calculation of the net, final and primary energy demand for heating, cooling, ventilation, domestic hot water and lighting*.
- [12] *DIN EN ISO 12569:2018-04: Thermal performance of buildings and materials - Determination of specific airflow rate in buildings - Tracer gas dilution method (German version EN ISO12569:2017)*.
- [13] *International Glazing Data Base, Lawrence Berkely National Lab* (<http://windows.lbl.gov/materials/IGDB/>).

- [14] knarF.se, "Wikimedia Commons - File:Roof Diagram.svg," 04 06 2014. [Online]. Available: [https://commons.wikimedia.org/wiki/File:Roof\\_Diagram.svg](https://commons.wikimedia.org/wiki/File:Roof_Diagram.svg). [Accessed 05 06 2019].
- [15] T. Hartmann, D. Reichel and W. Richter, "II/2: Feuchteabgabe in Wohnungen," in *Wohnungslüftung und Raumklima*, Stuttgart, Fraunhofer IRB; Helmut Künzle (Hrsg.), 2009, pp. 109-124.
- [16] Deutscher Wetterdienst (DWD), Aspirations-Psychrometer-Tafeln, Braunschweig: Vieweg, 1997.